



SERVIERARTIKEL AUS MELAMIN

SERVING ITEMS MELAMINE

ARTÍCULOS DE SERVICIO EN MELAMINA

PIÈCES DE SERVICE EN MÉLAMINE



2016
SINCE 1933

Icon-Index / Material-Index



neuer Artikel
new item



spülmaschinenfest
dishwasher-proof



bruchsicher
shatter-proof



1-a-Profiqualität
prime quality



nicht spülmaschinenfest
not dishwasher-proof



stapelbar
stackable



APS-Design



nicht mikrowellengeeignet
not microwave-proof



Eigenmontage
self assembly



GN-Größen
GN norm



keine direkte Hitze
not direct heat



für Lebensmittelkontakt
food safe



nicht für Backofen
not for bakin oven

APS - BSCI-Mitglied

APS engagiert sich für die Verbesserung von Arbeitsbedingungen.

Wir sind Partner der europäischen Organisation BSCI.

Die "Business Social Compliance Initiative" (BSCI) ist eine Initiative von Unternehmen zur Verbesserung der Arbeitsbedingungen in der globalen Versorgungskette.

APS is a member of BSCI

APS is committed to the improvement of working conditions

APS is a partner of the European organization BSCI

BSCI "Business Social Compliance Initiative" is an initiative of enterprises to improve working conditions in the global supply chain



APS Melamin - Garantierte Qualität

APS Melaminprodukte entsprechen der Richtlinie EG1935/2004 und 10/2011 der Europäischen Kommission. Diese enthält Bestimmungen für Materialien aus Kunststoff, welche mit Lebensmitteln in Berührung kommen. Wir arbeiten sehr eng mit den Zertifizierungsinstitutionen Intertek und TÜV zusammen und können somit die Lebensmittelechtheit (LFGB Regulation) der APS Melaminartikel garantieren.

APS Melamine - Guaranteed quality

APS melamine products comply with directive EG1935/2004 und 10/2011 of the European Commission. This contains provisions for plastic materials which come into contact with foodstuffs. We work very closely together with the certification institutions Intertek and TÜV, and are therefore able to guarantee the compatibility with foodstuffs (German LFGB regulation) of APS melamine articles.

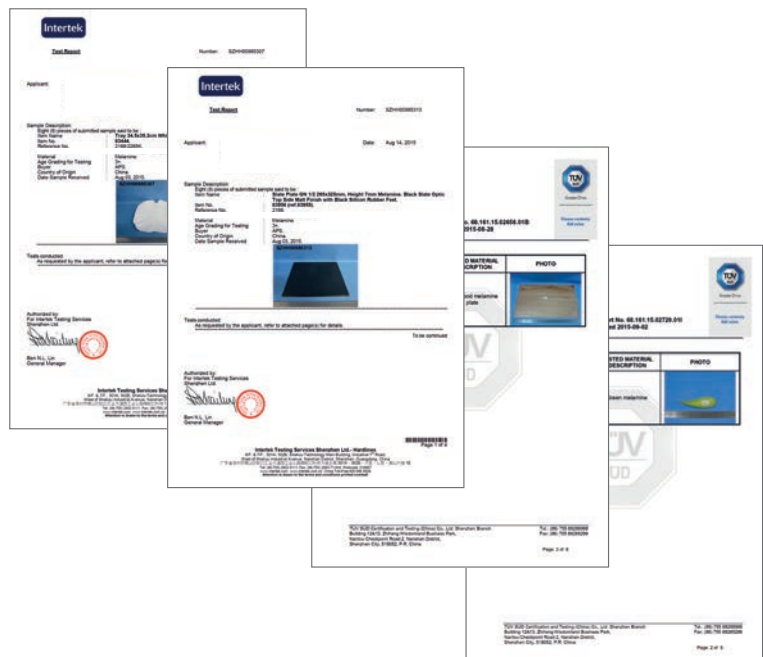

NEUHEITEN

NEWS

NOVEDAD

NOUVEAUTÉS

2016



APS+ - Seite/page 12



Tablets / trays „OAK LIGHT“ - Seite/page 22



Fullies - Seite/page 28



Tablets / trays „SLATE“ - Seite/page 29



LA VIDA - Seite/page 35

APS+

APS Plus – das multifunktionale Mix & Match Buffetsystem
Design by sieger design

Buffetwelten mit Mehrwert – wunderschön systematisch

APS Plus – Ein System, viele Gesichter

Immer wieder neu, immer wieder anders – APS Plus ermöglicht verschiedene Stilwelten und eröffnet nahezu unendlich viele Möglichkeiten, Speisen zu inszenieren. Dafür lassen sich die einzelnen Teile des Systems multifunktional mit-, in- und aufeinander kombinieren. So kann eine Schale auch Sockel für andere Teile sein, in unterschiedlichen Höhen wird Kulinarisches präsentiert und anschließend praktisch verwahrt. Mit dem Mix an Formen, Materialien und Oberflächen wird auch Fingerfood abwechslungsreich in Szene gesetzt. Damit entspricht das von sieger design gestaltete Buffetsystem den modernen Anforderungen der heutigen Gastronomie.

APS Plus – one system, many faces

Always new, always different – APS Plus enables a variety of styles and opens up almost endless options for presenting your dishes. The individual items in the multifunctional range can be combined with, in and on each other. Bowls can double as bases for other items, culinary creations can be presented at different heights and afterwards it can all be stored practically. The mix of forms, materials and surfaces also allows highly varied presentation of finger food, ensuring that the buffet range designed by sieger design meets the cutting-edge needs of modern gastronomy.

APS Plus – un sistema, muchas caras

Cada vez nuevo, cada vez diferente: APS Plus permite crear diferentes estilos y abre infinitas posibilidades para la puesta en escena de sus platos. Las piezas individuales del sistema se pueden combinar de forma multifuncional. Así, un cuenco puede servir de base para otras piezas, para presentar creaciones culinarias a diferentes alturas y almacenarlas después de una manera muy práctica. La mezcla de formas, materiales y superficies también permite presentar aperitivos de formas muy variadas. De este modo, el sistema de buffet diseñado por Sieger Design responde a las necesidades modernas de la gastronomía actual.

APS Plus – un système, de nombreux visages

Il se renouvelle sans cesse, adoptant des styles divers et offrant d'innombrables possibilités de présenter vos mets. Il vous suffit de jouer sur le caractère multifonctionnel de ses éléments en les combinant, les imbriquant et les empilant. Un récipient peut ainsi devenir le socle d'autres pièces pour une présentation sur différentes hauteurs, puis redevenir un récipient pratique pour son rangement. Le mélange des formes, matériaux et finitions est aussi propice à une présentation variée d'amuse-bouches. Le système signé sieger design répond ainsi aux exigences de la restauration d'aujourd'hui.

Funktionen / functions / functions / funciones

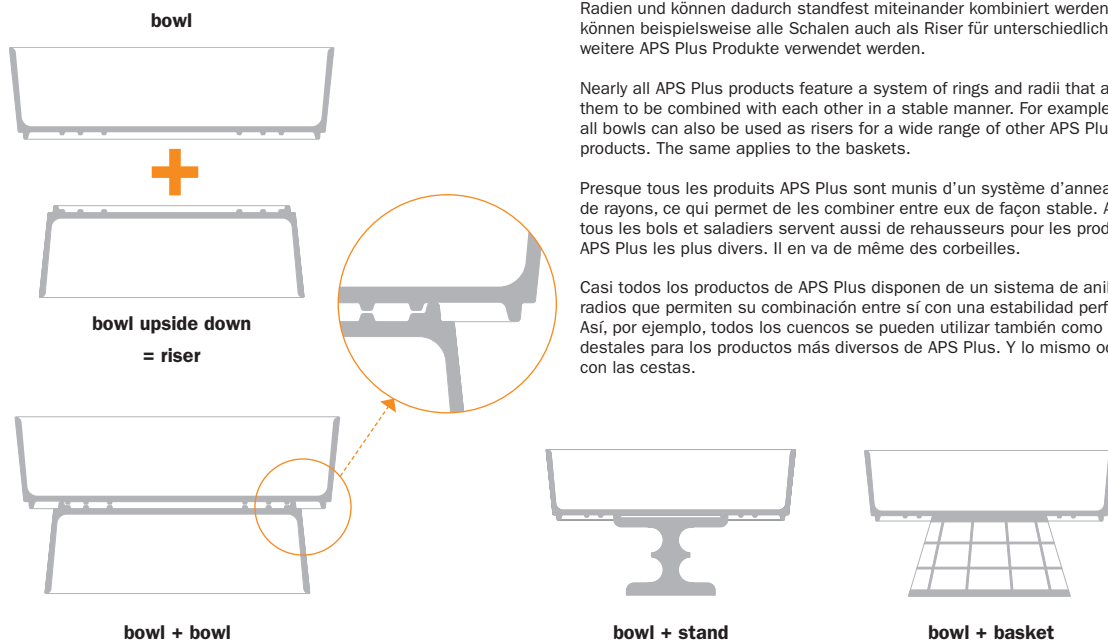

Universal

Bowls
S. 18

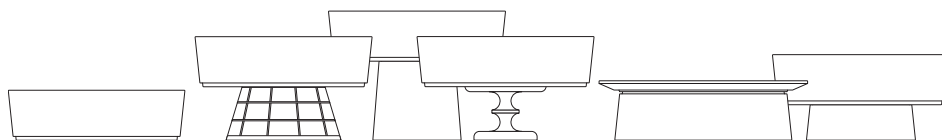

Antipasti

Flat Bowls
S. 22

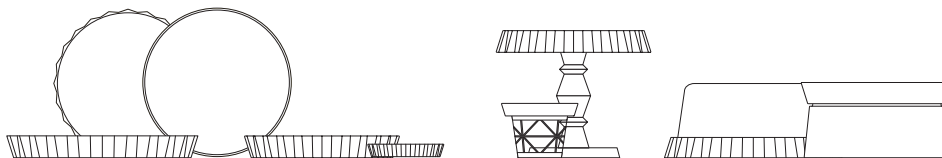

Bakery

Platters & Etagère
S. 24

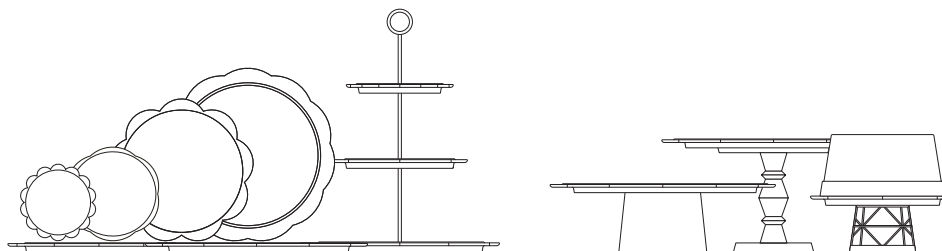

Lotus

Bowls & Platters
S. 26

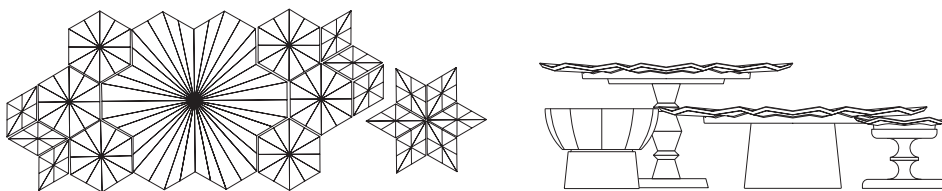

Wood

Platters & Stands
S. 29

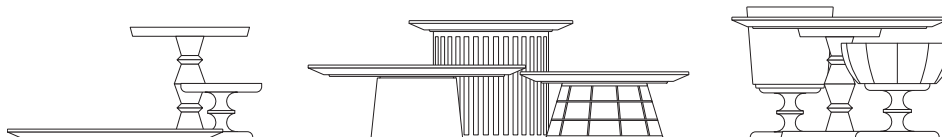

Tiles

Platters & Tray
S. 30

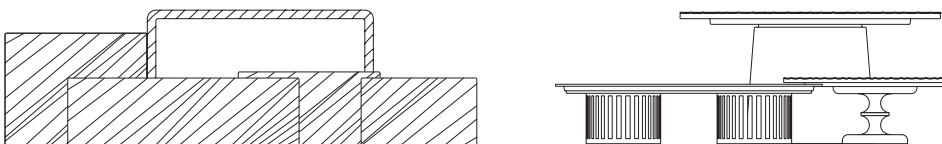

Baskets

Baskets & Riser
S. 32

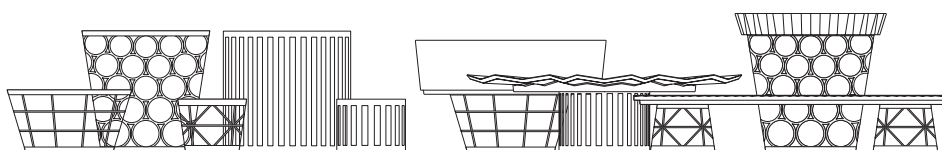

+ Kompatibilität / compatibility / compatibilité / combinación

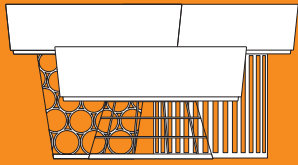

Baskets
risers

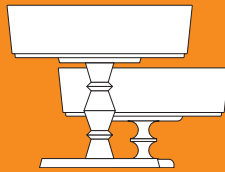

Wood
risers

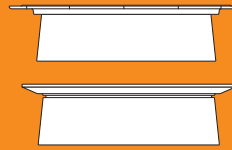

Bakery/Wood
plates

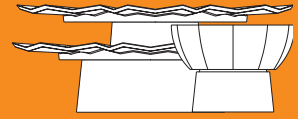

Lotus
bowls/plates



weiß; innen glänzend, außen matt
white; glossy on the inside, matt on the outside
blanc; intérieur brillant, extérieur mat
blanco; interior brillante, exterior mate



Holzdekor Ahorn & Farbe
maple wood decor & colour
aspect érable & couleur
textura de madera arce & color



Holzdekor Eiche dunkel & Farbe
oak wood decor & colour
aspect chêne foncé & couleur
textura de madera roble oscuro

bicolor
bicolour
bicolore
bicolor



bicolor
bicolour
bicolore
bicolor

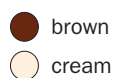



Schale, rund „UNIVERSAL“
bowl, round
cuenco, redondo
bol rond



	□ cm	↑ cm	ltr.	
15100 0	Ø 6,5	6	0,15	○
15101 7	Ø 9	4	0,15	○
15102 4	Ø 13	7	0,6	○
15103 1	Ø 16	12	1,5	○
15104 8	Ø 16	15	2,5	○
15105 5	Ø 20	7	1,5	○
15106 2	Ø 24	9	2,7	○
15107 9	Ø 26,5	9	3	○
15108 6	Ø 32,5	9	4	○

Schale, quadratisch „UNIVERSAL“
bowl, square
bol cuadrado
plat creux carré



15110

	□ cm	↑ cm	ltr.	
15110 9	6,5 x 6,5	6	0,15	○
15111 6	9 x 9	4	0,15	○
15112 3	13 x 13	7	0,6	○
15113 0	20 x 20	7	1,5	○
15114 7	24 x 24	9	3,5	○
15115 4	26,5 x 26,5	9	4	○



stapelbar
stackable



15111



15115

Schale, rechteckig „UNIVERSAL“
bowl, rectangular
cuenco
plat creux rectangulaire



GN 1/4
2 Höhen / 2 heights

15117

	□ cm	↑ cm	GN	ltr.	
15116 1	26,5 x 16,2	7	1/4	1,5	○
15117 8	26,5 x 16,2	9	1/4	2,5	○



15210



15230

Schale, rund „UNIVERSAL“
bowl, round
cuenco, redondo
bol rond



Holzdekor Ahorn & Farbe
 maple wood decor & colour
 aspect érable & couleur
 textura de madera arce & color

	☐ cm	↑ cm	litr.	
15210 6	Ø 13	7	0,6	● ○
15211 3	Ø 20	7	1,5	● ○
15212 0	Ø 24	9	2,7	● ○
15213 7	Ø 26,5	9	3	● ○
15214 4	Ø 32,5	9	4	● ○
15230 4	Ø 20	7	1,5	● ●
15231 1	Ø 32,5	9	4	● ●

Schale, quadratisch „UNIVERSAL“
bowl, square
bol cuadrado
plat creux carré



Holzdekor Eiche dunkel & Farbe
 oak wood decor & colour
 aspect chêne francé couleur
 textura de madera roble oscuro & color



15216



15233

	☐ cm	↑ cm	litr.	
15215 1	13 x 13	7	0,6	● ○
15216 8	20 x 20	7	1,5	● ○
15217 5	24 x 24	9	3,5	● ○
15218 2	26,5 x 26,5	9	4	● ○
15232 8	20 x 20	7	1,5	● ●
15233 5	26,5 x 26,5	9	4	● ●

Schale, rechteckig „UNIVERSAL“
bowl, rectangular
cuenco
plat creux rectangulaire



Holzdekor Eiche dunkel & Farbe
 oak wood decor & colour
 aspect chêne francé couleur
 textura de madera roble oscuro & color



15219

GN 1/4
 2 Höhen / 2 heights



15234

	☐ cm	↑ cm	GN	litr.	
15219 9	26,5 x 16,2	7	1/4	1,5	● ○
15220 5	26,5 x 16,2	9	1/4	2,5	● ○
15234 2	26,5 x 16,2	7	1/4	1,5	● ●
15235 9	26,5 x 16,2	9	1/4	2,5	● ●



15235

**Schale „UNIVERSAL“
bowl
cuenco
bol**



15200



15204



15201



15205



15203

Round	□ cm	↑ cm	ltr.	
15200 7	Ø 6,5	6	0,15	● ○
15201 4	Ø 9	4	0,15	● ○
15202 1	Ø 16	12	1,5	● ○
15203 8	Ø 16	15	2,5	● ○

Square	□ cm	↑ cm	ltr.	
15204 5	6,5 x 6,5	6	0,15	● ○
15205 2	9 x 9	4	0,15	● ○

**Deckel „UNIVERSAL“
cover
tapa
couverture seul**



glasklar, mit Löffelaussparung
transparent, with notched for spoons
transparent, avec encoche pour la cuillère
Plástico, con espacio para oja cuchara



15340-15344



15345-15347



15348

Round	□ cm	↑ cm	
15340 0	Ø 16	1,5	○ transparent
15341 7	Ø 20	1,5	○ transparent
15342 4	Ø 24	1,5	○ transparent
15343 1	Ø 26,5	1,5	○ transparent
15344 8	Ø 32,5	1,5	○ transparent

Square	□ cm	↑ cm	
15345 5	20 x 20	1,5	○ transparent
15346 2	24 x 24	1,5	○ transparent
15347 9	26,5 x 26,5	1,5	○ transparent

Rectangular	□ cm	↑ cm	GN	
15348 6	26,5 x 16,2	1,5	1/4	○ transparent



+ Kompatibilität / compatibility / compatibilité / combinación

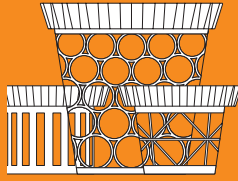

Baskets
risers

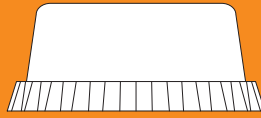

Cover
seal

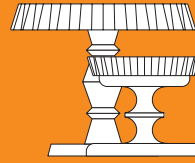

Wood
risers

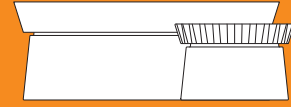

Bowls
risers



15140



15141



15142

Schale „PLISSEE“
bowl
cuenco
bol



	cm	cm	
15140 6	Ø 14,5	2,5	○
15141 3	Ø 25	3,5	○
15142 0	Ø 35	4	○



**Schale
bowl
cuenco
bol**



	□ cm	↑ cm	
15135 2	Ø 14,5	2,5	○
15136 9	Ø 25	3,5	○
15137 6	Ø 35	4	○

3 Größen / 3 sizes



15136



15137



15270

3 Größen / 3 sizes

**Schale
bowl
cuenco
bol**



Holzdekor Ahorn & Farbe
maple wood decor & colour
aspect érable & couleur
textura de madera arce & color

	□ cm	↑ cm	
15270 0	Ø 14,5	2,5	● ○
15271 7	Ø 25	3,5	● ○
15272 4	Ø 35	4	● ○



15271



3mm Materialstärke

**Frischhalte-Haube
cover
campana
cloche bombée**



glasklar, Griff verchromt
transparent, chrome knob
transparent, asa cromada
transparente, ansa cromée

	□ cm	↑ cm	matches
15351 6	Ø 20,5	10	15141 15136 15271
06512 3	Ø 30	11,5	15142 15137 15272



15351



06512

+ Kompatibilität / compatibility / compatibilit  / combinaci n

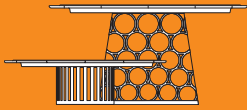

Baskets
risers

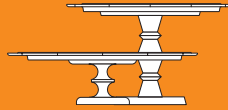

Wood
risers

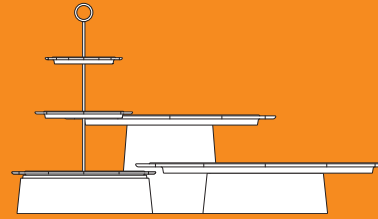

Universal
risers



**Tablett „BAKERY“
tray
bandeja
plateau**



15130



15131



15132
15133

	□ cm	↑ cm	
15130 7	Ø 18,5	1,5	○
15131 4	Ø 23,5	1,5	○
15132 1	Ø 35	1,5	○
15133 8	Ø 42,5	1,5	○

**Etagère „BAKERY“
etagère
estante
presentoir**



	□ cm	↑ cm	
15160 4	Ø 35/23,5/18,5	40	○



3mm Materialstärke



15350,
15351

15130,
15131

18388



15133

**Frischhalte-Haube
cover
campana
cloche bombée**



glasklar, Griff verchromt
transparent, chrome
transparent, asa cromada
transparente, ansa cromée

	□ cm	↑ cm	matches	
15350 9	Ø 16,5	10	15130	○ transparent
15351 6	Ø 20,5	10	15131	○ transparent
06512 3	Ø 30	11,5	15132	○ transparent
06517 8	Ø 33	12,5	15133	○ transparent
Rolltop Cover				
18388 9	Ø 38	20	15133	○ transparent



06517

15133

+ Kompatibilität / compatibility / compatibilit  / combinaci n

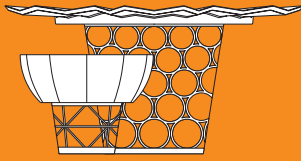

Baskets
risers

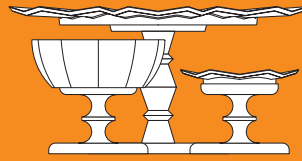

Wood
risers

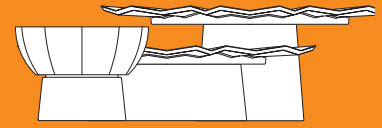

Universal
risers





○ 15152

Blattschale large „LOTUS“
leaf large
fuente en forma de hoja
plat feuille



	☐ cm	↑ cm	
15152 9	∅ 46,5	2,5	○ white
15257 1	∅ 46,5	2,5	● green
15263 2	∅ 46,5	2,5	● dark green



● 15267



● 15263



○ 15151

Blattschale medium „LOTUS“
leaf medium
fuente en forma de hoja
plat feuille



	☐ cm	↑ cm	
15151 2	∅ 17,5	2,5	○ white
15259 5	∅ 17,5	2,5	● yellow green
15256 4	∅ 17,5	2,5	● green
15262 5	∅ 17,5	2,5	● dark green



● 15259



● 15256



● 15262



○ 15150

Blattschale small „LOTUS“
leaf medium
fuente en forma de hoja
plat feuille



	☐ cm	↑ cm	
15150 5	15 x 8,5	2,5	○ white
15258 8	15 x 8,5	2,5	● yellow green
15255 7	15 x 8,5	2,5	● green
15261 8	15 x 8,5	2,5	● dark green

● 15261



● 15255

● 15258

○ 15150

Schale Water Lily „LOTUS“
leaf
fuente en forma de hoja
plat feuille



	cm	cm	litr.	
15165 9	Ø 8,5	4	0,1	○
15166 6	Ø 13	6	0,3	○
15167 3	Ø 20	7	1,25	○



15165
0,1 ltr.



15166
0,3 ltr.



15167
1,25 ltr.

Schale Water Lily „LOTUS“
leaf
fuente en forma de hoja
plat feuille



	cm	cm	litr.	
15206 9	Ø 8,5	4	0,1	●○
15207 6	Ø 13	6	0,3	●○
15208 3	Ø 20	7	1,25	●○



15206
0,1 ltr.



15207
0,3 ltr.



15208
1,25 ltr.

+ Kompatibilität / compatibility / compatibilité / combinación

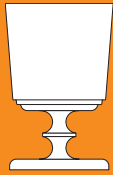

Universal
bowls

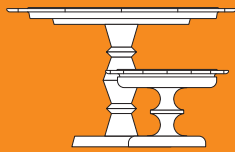

Tiles
plates

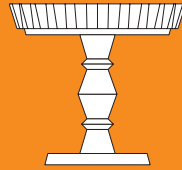

Antipasti
flat bowls

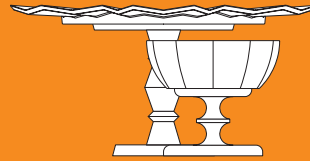

Lotus
plates/bowls

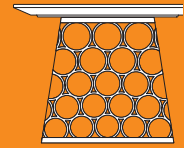

Baskets
risers



15300



15303

Tablett „WOOD“
tray
bandeja
plateau



- Eiche dunkel oder ● Ahorn
- oak or ● maple
- chêne foncé ou ● érable
- Roble oscuro o ● Arce

	cm	cm		matches
15300 4	Ø 30	2	●	all stands, bowls
15301 1	Ø 30	2	●	all stands, bowls
15302 8	Ø 38,5	2	●	all stands, bowls
15303 5	Ø 38,5	2	●	all stands, bowls



15312



15311

Ständer „WOOD“
stand
soporte
support



- Eiche dunkel oder ● Ahorn
- oak or ● maple
- chêne foncé ou ● érable
- Roble oscuro o ● Arce

	cm	cm		matches
15310 3	Ø 15/11,5	10,5	●	all plates, bowls
15311 0	Ø 15/11,5	10,5	●	all plates, bowls
15312 7	Ø 21/15	20	●	all plates, bowls
15313 4	Ø 21/15	20	●	all plates, bowls



06517

15303

15313



Rolltop Cover
18388

Frischhalte-Haube
cover
campana
cloche



glasklar
clear
transparente
transparente

	cm	cm	matches
06517 8	Ø 33	12,5	15302, 15303
18388 9	Ø 38	20	15302, 15303

+ Kompatibilität / compatibility / compatibilit  / combinaci n

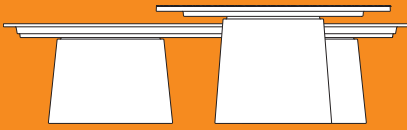

Bowls
risers

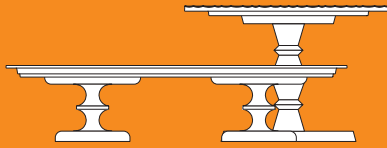

Wood
risers

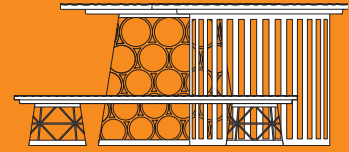

Baskets
risers



Tablett „TILES“
tray
bandeja
plat



	▣ cm	↑ cm	GN	
15120 8	53 x 32,5	2	1/1	○ white
15236 6	53 x 32,5	2	1/1	● black

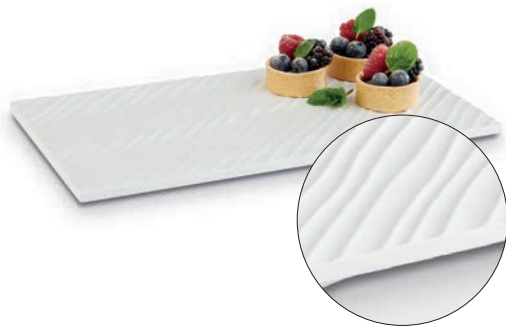

Tablett „TILES“
tray
bandeja
plat



weiß / white / blanc / blanco

	□ cm	↑ cm	GN	
15125 3	26,5 x 16,2	1,5	1/4	○
15126 0	35,5 x 17,6	1,5	1/3	○
15128 4	32,5 x 26,5	1,5	1/2	○
15127 7	53 x 16,2	1,5	2/4	○

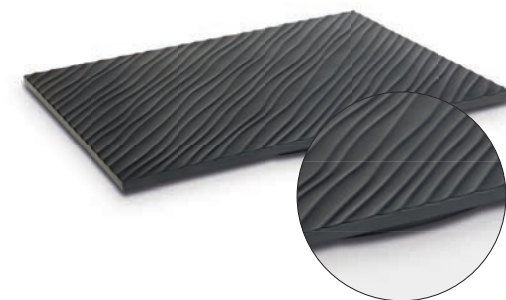

Tablett „TILES“
tray
bandeja
plat



schwarz / black / noir / negro

	□ cm	↑ cm	GN	
15250 2	26,5 x 16,2	1,5	1/4	●
15251 9	32,5 x 17,5	1,5	1/3	●
15253 3	32,5 x 26,5	1,5	1/2	●
15252 6	53,0 x 16,2	1,5	2/4	●



Tablett „TILES“
tray
bandeja
plat



Holzdekor Ahorn / maple wood decor / aspect érable / textura de madera arce

	□ cm	↑ cm	GN	
15221 2	26,5 x 16,2	1,5	1/4	●
15222 9	32,5 x 17,6	1,5	1/3	●
15224 3	32,5 x 26,5	1,5	1/2	●
15223 6	53 x 16,2	1,5	2/4	●



Tablett „TILES“
tray
bandeja
plat



Holzdekor Eiche dunkel / oak wood decor / aspect chêne foncé / textura de madera

	□ cm	↑ cm	GN	
15225 0	26,5 x 16,2	1,5	1/4	●
15226 7	32,5 x 17,5	1,5	1/3	●
15228 1	32,5 x 26,5	1,5	1/2	●
15227 4	53,0 x 16,2	1,5	2/4	●

+ Kompatibilität / compatibility / compatibilité / combinación

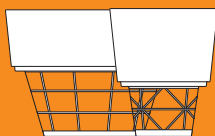

Universal
bowls

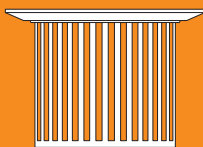

Wood
plates

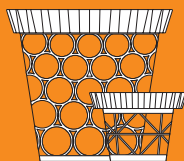

Antipasti
flat bowls



Tiles
plates

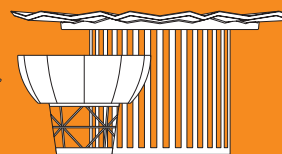

Lotus
plates/bowls





Korb/Ständer
basket/riser
cestas/soporte
corbeilles/support



schwarz / black / noir / negro

	☐ cm	↑ cm	
15326 4	Ø 21/15	21	● black

15326

15326



Korb/Ständer
basket/riser
cestas/soporte
corbeilles/support



Metall / metal / métal / metálico

	☐ cm	↑ cm	
15321 9	Ø 21/15	11	● chrome
15325 7	Ø 21/15	11	● gold brushed
15323 3	Ø 21/15	11	● copper

15321

15325

15323



Korb/Ständer
basket/riser
cestas/soporte
corbeilles/support



Metall / metal / métal / metálico

	☐ cm	↑ cm	
15320 2	Ø 10,5/8	8	● chrome
15324 0	Ø 10,5/8	8	● gold brushed
15322 6	Ø 10,5/8	8	● copper

15320

15324



Korb/Ständer
basket/riser
cestas/soporte
corbeilles/support



Chrom poliert / polished chrome / chrome poli / color plata brillante

	☐ cm	↑ cm	
15331 8	Ø 15	10,5	● chrome
15332 5	Ø 21	20	● chrome

15332

15331



Korb/Ständer
basket/riser
cestas/soporte
corbeilles/support



Gold, gebürstet / brushed gold / doré brossé / dorado cepillado

	☐ cm	↑ cm	
15334 9	Ø 15	10,5	● gold brushed
15335 6	Ø 21	20	● gold brushed

15335

15334

OAK LIGHT



NEW

Tablett „OAK LIGHT“
tray
bandeja
plateau



die Melaminplatten (Holzoptik Eiche) haben eine leichte Struktur und wirken optisch wie aus Holz gefertigt

superb oak wood effect, cutting edge gourmet presentation idea, never produce mould or sawdust, clean and hygienic, no more worries about crack

melamina imitación madera de roble, para recetas auténticas

mélamine imitation chêne, pour vos recettes authentiques



84262
Ø 35 cm



84263
Ø 44 cm



84264



84265

	□ cm	↑ cm
84262 5	Ø 35	3
84263 2	Ø 44	3
84264 9	44 x 25	1,5
84265 6	65 x 26	3

Tablett „OAK LIGHT“
tray
bandeja
plateau



die Melaminplatten (Eiche-Holzoptik) haben eine leicht wellige Oberfläche und wirken optisch wie aus Holz gefertigt

imagine the durability of melamine and the beauty of oak-wood - fantastic imitation of wood
 melamina imitación madera: madera con la durabilidad de la melamina gracias a la superficie ligeramente irregular de la melamina

mélamine imitation bois: toute bois mais avec la durabilité de la mélamine, la surface irrégulière renforce l'aspect naturel

	☐ cm	↑ cm	GN
84205 2	53,0 x 32,5	1,5	1/1
84206 9	32,5 x 26,5	1,5	1/2
84207 6	32,5 x 17,6	1,5	1/3
84208 3	26,5 x 16,2	1,5	1/4
84209 0	53,0 x 16,2	1,5	2/4

Gastronorm - Außenmaße

Gastronorm - size

Gastronorm - medidas exteriores

Gastronorme - Diensions extérieures



GN1/2
84206



GN1/4
84208

GN1/4
84208

GN1/2
84206

GN2/4
84209



Platte „TIMBER“
plate
bandeja
plateau



die Melaminplatten (Holzoptik Fichte) haben eine leichte Struktur und wirken optisch wie aus Holz gefertigt

superb spruce wood effect (timber), cutting edge gourmet presentation idea, never produce mould or sawdust, clean and hygienic, no more worries about crack

melamina imitación madera de picea, para recetas auténticas

mélamine imitation spruce, pour vos recettes authentiques



Ø 35 cm
 Ø 44 cm

	□ cm	↑ cm
84266 3	Ø 35	3
84267 0	Ø 44	3
84268 7	44 x 25	1,5
84269 4	65 x 26	3



84268



84269



OAK



84177

**Tablett „OAK“
tray
bandeja
plateau**



die Melaminplatten (Holzoptik Eiche) haben eine leichte Struktur und wirken optisch wie aus Holz gefertigt

superb oak wood effect, cutting edge gourmet presentation idea, never produce mould or sawdust, clean and hygienic, no more worries about crack

melamina imitación madera de roble, para recetas auténticas

mélamine imitation chêne, pour vos recettes authentiques

	□ cm	↑ cm	Grifflänge / handle cm
84177 2	Ø 30	1,5	12
84178 9	40 x 20	1,5	13
84179 6	48 x 20	1,5	13



84178

84179

Holzoptik



Gastronorm - Außenmaße
Gastronorm - size
Gastronorm - medidas exteriores
Gastronorme - Diensions extérieures

Tablett „DRIFTWOOD“
tray
bandeja
plateau



die Melaminplatten (Holzoptik) haben eine leicht wellige Oberfläche und wirken optisch wie aus Holz gefertigt

imagine the durability of melamine and the beauty of wood - fantastic imitation of wood

melamina imitación madera: madera con la durabilidad de la melamina gracias a la superficie ligeramente irregular de la melamina.

mélamine imitation bois: toute bois mais avec la durabilité de la mélamine, la surface irrégulière renforce l'aspect naturel

	☐ cm	↑ cm	GN
84180 2	53,0 x 32,5	1,5	1/1
84181 9	32,5 x 26,5	1,5	1/2
84182 6	32,5 x 17,6	1,5	1/3
84183 3	26,5 x 16,2	1,5	1/4
84184 0	53,0 x 16,2	1,5	2/4



GN1/3
84182

Granitoptik

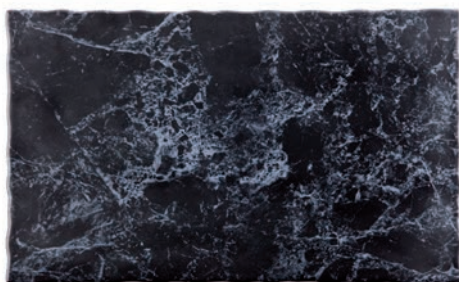

Gastronorm - Außenmaße
Gastronorm - size
Gastronorm - medidas exteriores
Gastronorme - Diensions extérieures

Tablett „GRANIT“
tray
bandeja
plateau



die Melaminplatten (Granitoptik) haben eine leicht wellige Oberfläche und wirken optisch wie der Naturstein Granit

fantastic imitation of granit stone

Melamina: excelente imitación del granito natural con el acabado irregular de la superficie de la melamina.

Mélamine imitation granit naturel. La surface irrégulière renforce l'aspect de la pierre naturelle.

	☐ cm	↑ cm	GN
84190 1	53,0 x 32,5	1,5	1/1
84191 8	32,5 x 26,5	1,5	1/2
84192 5	32,5 x 17,6	1,5	1/3
84193 2	26,5 x 16,2	1,5	1/4
84194 9	53,0 x 16,2	1,5	2/4



GN1/4
84193

ZERO



Gastronorm - Außenmaße
 Gastronorm - size
 Gastronorm - medidas exteriores
 Gastronorme - Diensions extérieures

Tablett „ZERO“
 tray
 bandeja
 plat



	▣ cm	↑ cm	GN	
84185 7	53,0 x 32,5	1,5	1/1	○
84186 4	32,5 x 26,5	1,5	1/2	○
84187 1	32,5 x 17,6	1,5	1/3	○
84188 8	26,5 x 16,2	1,5	1/4	○
84189 5	53,0 x 16,2	1,5	2/4	○
84195 6	53,0 x 32,5	1,5	1/1	●
84196 3	32,5 x 26,5	1,5	1/2	●
84197 0	32,5 x 17,6	1,5	1/3	●
84198 7	26,5 x 16,2	1,5	1/4	●
84199 4	53,0 x 16,2	1,5	2/4	●



glatte Oberfläche
 smooth surface

mit Antirutsch-Füßchen
 non-slip feet
 con pies antideslizantes
 avec pieds anti-dérapants

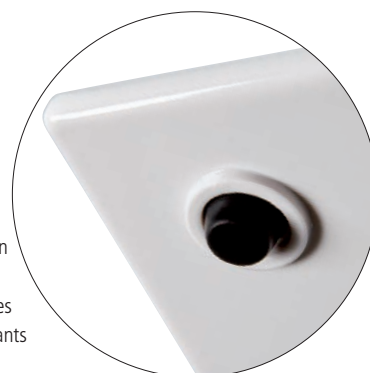



84312



84314



84217

**Schale „FULLIES“
bowl
bol
plat**



	□ cm	↑ cm	ltr.	
84312 7	Ø 8	4	0,1	● white/mint
84314 1	Ø 8	4	0,1	● white/yellow
84217 5	Ø 8	4	0,1	● black/white



84315



84317



84218

**Schale „FULLIES“
bowl
bol
plat**



	□ cm	↑ cm	ltr.	
84315 8	Ø 8,5	3,5	0,05	● white/mint
84317 2	Ø 8,5	3,5	0,05	● white/yellow
84218 2	Ø 8,5	3,5	0,05	● black/white



Tablett „SLATE“
tray
bandeja
plat



	□ cm	↑ cm	Grifflänge (cm)	Loch (cm)
84240 3	Ø 18,5	1,5	8,5	1,5
84241 0	Ø 23	1,5	10	2
84242 7	Ø 34	1,5	14	2,5
84243 4	Ø 37	1,5	15,5	3

Zubehör / spare parts / recambios / pièces de rechange



Haube / cover / campana / cloche

	□ cm	↑ cm	matches
15350 9	Ø 16,5	10	84240
15351 6	Ø 20,5	10	84241
06512 3	Ø 30	11,5	84242
06517 8	Ø 33	12,5	84243

passende Hauben / covers
15350, 15351



passende Tablett / trays
84240, 84241

passende Hauben / covers
06512, 80657



passende Tablett / trays
84242, 84243

SLATE



Die schwarzen Melaminplatten überzeugen mit ihrem edlen und schlichten Schieferlook.

Fantastic imitation of slate. This plates add a rustic feel to your display. Perfect Presentation for cluse, chocolates, pastry and meat.

Las bandejas de melamina negras ofrecen un aspecto de pizarra elegante y discreto.

Les plats en mélamine noire offrent l'aspect de l'ardoise, élégants et discrets.

NEW

Tablett „SLATE“ tray bandeja plat



mit Antirutsch-Füßchen

	cm	↑ cm
83992 2	Ø 30	1
83994 6	Ø 40	1



Ø 30 cm



Ø 40 cm

mit Antirutsch-Füßchen
non-slip feet
con pies antideslizantes
pieds anti-dérapants

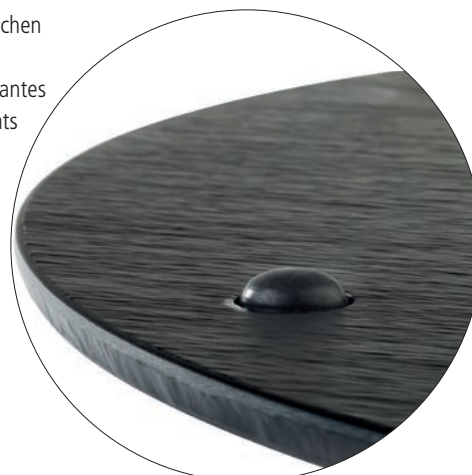



GN 1/1

GN-Tablett „SLATE“
tray
bandeja
plat



	cm	cm	GN
83981 6	53,0 x 32,5	1,5	1/1

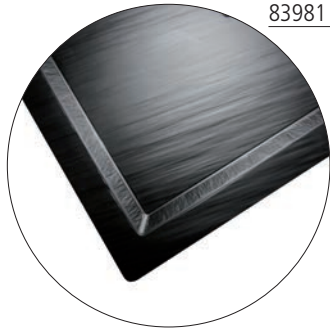

Schieferoptik



Gastronorm-Maße
gastronorm-sizes

Tablett „SLATE“
tray
bandeja
plat



	cm	cm	GN
83955 7	53,0 x 32,5	1	1/1
83956 4	32,5 x 26,5	1	1/2
83957 1	32,5 x 17,5	1	1/3
83958 8	26,5 x 16,2	1	1/4
83971 7	53,0 x 16,2	1	2/4

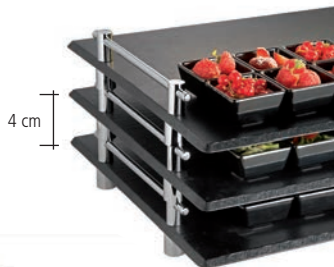

4 cm

Tablett „SLATE HOCHSTAPLER“
tray
bandeja
plat empilable système catering



massive Metallgriffe verchromt inkl. fest verschraubten 4 cm Distanzstücken
chrome plated handles, incl. mounted 4 cm distance pillars
asas cromadas, incluye distanciadores a 4 cm
poignées chromées, distance approx. 4 cm



GN 1/1

	cm	cm	GN
83980 9	53,0 x 32,5	6	1/1

Schieferoptik



Schale „SLATE“
bowl
cuenco
bol



	cm	cm	ltr.
84245 8	25,0 x 25,0	12	3,8



Das Wechselspiel zwischen den hoch glänzenden Innenflächen und dem matten Rand bilden einen stilvollen Rahmen für die Präsentation Ihrer Speisen. Der breite Rand sorgt dabei für ein optimales und unkompliziertes Handling im täglichen Einsatz. Die in den Farben Weiss und Terrakotta erhältlichen Artikel eignen sich gleichermaßen für die Speisenpräsentation auf dem Tisch, in der Theke oder auf dem Buffet.

The interplay between mirror shiny insides and matt finished edges is the base for a stylish presentation of your food. An optimally and uncomplicated handling due to the wide edge in your daily use is guaranteed.

The articles are available in white and terracotta colored. They are similarly suitable for the food presentation for table top, countertop or buffet setting.

El contraste entre el exterior y bordes an acabado mate y el interior brillante da un toque elegante y de calidad a sus presentaciones culinarias. La colección se declina en 2 colores: arcilla y blanco. La colección es perfecta tanto para la mesa como para el mostrador, las vitrinas o el buffet.

Style et élégance : La finition mate de l'extérieur et des rebords offre un élégant contraste avec l'intérieur brillant des différentes pièces de la collection qui se décline en deux couleurs : blanc et argile. La gamme s'adapte parfaitement pour le service de table, comme pour le comptoir ou le buffet.



GN 1/1
GN 1/2

Tablett „TIERRA“
tray
bandeja
plateau



	□ cm	↑ cm	GN	
84270 0	53,0 x 32,5	2,5	1/1	●
84271 7	32,5 x 26,5	2,5	1/2	●
84280 9	53,0 x 32,5	2,5	1/1	○
84281 6	32,5 x 26,5	2,5	1/2	○



GN 2/4

Tablett „TIERRA“
tray
bandeja
plateau



	□ cm	↑ cm	GN	
84272 4	53,0 x 16,2	2,5	2/4	●
84282 3	53,0 x 16,2	2,5	2/4	○



oval

Schale, oval „TIERRA“
bowl, oval
cuenco, ovalada
bol, ovale



	□ cm	↑ cm		
84275 5	40 x 20	2,5		●
84285 4	40 x 20	2,5		○



1 Liter und 2,5 Liter

Schale „TIERRA“
bowl
cuenco
bol



	□ cm	↑ cm	ltr.	
84273 1	19 x 19	8	1	●
84274 8	25 x 25	10	2,5	●
84283 0	19 x 19	8	1	○
84284 7	25 x 25	10	2,5	○



Ø 32 cm und
Ø 40,5 cm

Teller „TIERRA“
tray
bandera
plateau



	□ cm	↑ cm		
84276 2	Ø 32,0	3,5		●
84277 9	Ø 40,5	5,5		●
84286 1	Ø 32,0	3,5		○
84287 8	Ø 40,5	5,5		○

Schale „TIERRA“
bowl
cuenco
bol



	□ cm	↑ cm	litr.	
84290 8	Ø 10	7	0,13	●
84295 3	Ø 10	7	0,13	○

Teller „TIERRA“
tray
bandeja
plateau



	□ cm	↑ cm	litr.	
84291 5	Ø 13,5	3	0,13	●
84296 0	Ø 13,5	3	0,13	○

Tablett „TIERRA“
tray
bandeja
plateau



oval flach

	□ cm	↑ cm		
84292 2	21,5 x 10,5	1,5		●
84297 7	21,5 x 10,5	1,5		○

Schale „TIERRA“
bowl
cuenco
bol



oval hoch

	□ cm	↑ cm	litr.	
84293 9	17,0 x 8,5	4	0,2	●
84298 4	17,0 x 8,5	4	0,2	○



Teller/Tablett „LA VIDA“
plate/tray
plato/bandeja
assiette/plateau



	□ cm	↑ cm		GN
84161 1	Ø 32,0	3,5	●	
84170 3	Ø 40,5	5,5	●	
84165 9	Ø 32,0	3,5	●	
84168 0	Ø 40,5	5,5	●	
84171 0	Ø 32,0	3,5	●	
84172 7	Ø 40,5	5,5	●	
84144 4	53,0 x 32,5	2,5	●	1/1
84145 1	32,5 x 26,5	2,5	●	1/2
84146 8	53,0 x 16,2	2,5	●	2/4
84147 5	53,0 x 32,5	2,5	●	1/1
84148 2	32,5 x 26,5	2,5	●	1/2
84149 9	53,0 x 16,2	2,5	●	2/4

NEW

NEW

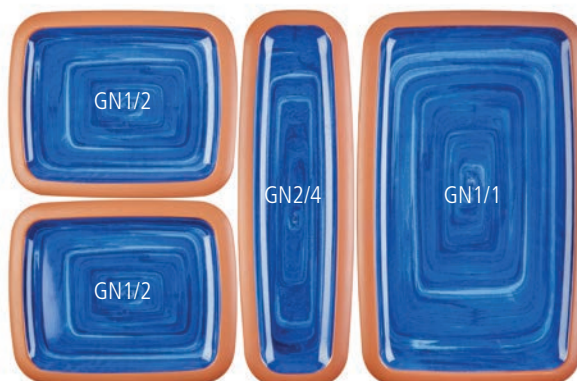



84320



rund/round

**Tablett/Teller „AIKO“
tray
bandeja
plat**



Steinoptik
appearance stoneware
su aspecto recuerda al gres
l'aspect de la mélamine rapelle le grès

	☐ cm	↑ cm	
84320 2	Ø 16	2	○
84321 9	Ø 16	2	●
84322 6	Ø 26,5	2,5	○
84323 3	Ø 26,5	2,5	●



84322



oval

Tablett/Teller „AIKO“
tray
bandeja
plat



Steinoptik
 appearance stoneware
 su aspecto recuerda al gres
 l'aspect de la mélamine rapelle le grès

	▣ cm	↑ cm	
84324 0	33 x 25	2,5	○
84325 7	33 x 25	2,5	●



oval

Schale „AIKO“
bowl
cuenco
bol



Steinoptik
 appearance stoneware
 su aspecto recuerda al gres
 l'aspect de la mélamine rapelle le grès

	▣ cm	↑ cm	ltr.	
84326 4	26,5 x 19,5	6	0,9	○
84327 1	26,5 x 19,5	6	0,9	●



84328



84331

Schale „AIKO“
bowl
cuenco
bol



Steinoptik
 appearance stoneware
 su aspecto recuerda al gres
 l'aspect de la mélamine rapelle le grès

	▣ cm	↑ cm	ltr.	
84328 8	Ø 8	4	0,07	○
84329 5	Ø 8	4	0,07	●
84330 1	Ø 11,5	6	0,2	○
84331 8	Ø 11,5	6	0,2	●



0,3 - 1,2 ltr.

84337

Schale „AIKO“
bowl
cuenco
bol



Steinoptik
 appearance stoneware
 su aspecto recuerda al gres
 l'aspect de la mélamine rapelle le grès

	▣ cm	↑ cm	ltr.	
84332 5	Ø 12,5	6	0,3	○
84333 2	Ø 12,5	6	0,3	●
84334 9	Ø 16	7	0,6	○
84335 6	Ø 16	7	0,6	●
84336 3	Ø 20,5	8	1,2	○
84337 0	Ø 20,5	8	1,2	●

MARONE



schwarze Serie in Naturoptik mit braunem Rand

Body in black with brown edge

Formas orgánicas con aspecto parecido a materiales naturales, color negro con borde marrón

Formes organiques à l'apparence proche du naturel, couleur noire avec rebords marron.



84100

Blattschale „MARONE“
leaf
fuente en forma de hoja
plat fenille



	▣ cm	↑ cm	litr.
84100 0	25,5 x 14	5,5	0,4
84101 7	36 x 19	8	0,9



84101

Tablett „MARONE“
tray
bandeja
plat



	▣ cm	↑ cm
84103 1	14,5 x 14,5	2



Tablett „MARONE“
tray
bandeja
plat



	▣ cm	↑ cm
84104 8	22,5 x 15	3
84105 5	27,5 x 11	2



Tablett „MARONE“
tray
bandeja
plat



	▣ cm	↑ cm
84106 2	26,5 x 16,5	4

NEW



Schale „MARONE“
bowl
cuenco
bol



	cm	cm	ltr.
84114 7	23,5 x 23,5	6,5	0,70

NEW



84116

Schale „MARONE“
bowl
cuenco
bol



	cm	cm	ltr.
84115 4	Ø 11	3,5	0,13
84116 1	Ø 14	4	0,20



84113

Schale „MARONE“
bowl
cuenco
bol



	cm	cm	ltr.
84110 9	Ø 14	6	0,30
84111 6	Ø 19	8	0,80
84112 3	Ø 21	8,5	1,00
84113 0	Ø 24	9,5	1,40



Schale „MARONE“
bowl
cuenco
bol



	cm	cm	ltr.
84109 3	Ø 11	5,5	0,2



Schale „MARONE“
tray
bandeja
plat



	cm	cm	ltr.
84107 9	Ø 8,5	2,5	0,05



Schale „MARONE“
bowl
cuenco
bol



	cm	cm	ltr.
84108 6	Ø 11,5	3	0,04

ZEN



Fernöstliche Tisch- und Buffetartikel präsentiert die Serie **ZEN**.

Japanische und chinesische Köstlichkeiten können traditionell in Szene gesetzt werden. Die Optik entspricht dem japanischen Steingut.

The **ZEN** series presents Far Eastern table and buffet articles.

Japanese and Chinese specialties can be served in a traditional setting.

The appearance is that of Japanese stoneware.

La colección **ZEN** presenta artículos de bufé y mesa para cocina oriental. Las delicias japonesas y chinas se pueden poner en escena siguiendo la tradición. Su aspecto recuerda al gres japonés.

La collection **ZEN** présente des articles de buffet et de table pour la cuisine orientale. Les délices japonaises et chinoises entrent en scène selon la plus pure tradition. L'aspect de la mélamine rappelle le grès japonais.



Schale „ZEN“
bowl
cuenco
bol



	▣ cm	↑ cm	
83928 1	Ø 31	8,5	○
83929 8	Ø 31	8,5	●



Schale „ZEN“
bowl
cuenco
bol



	▣ cm	↑ cm	litr.	
83710 2	21 x 21	11	1,4	○
83712 6	21 x 21	11	1,4	●

NEW



Schale „ZEN“
bowl
cuenco
bol



	cm	cm	litr.	
84354 7	Ø 22,5	12,5	0,80	○
84355 4	Ø 22,5	12,5	0,80	●

NEW



84351

Schale „ZEN“
bowl
cuenco
bol



	cm	cm	litr.	
84348 6	Ø 10	7	0,08	○
84349 3	Ø 10	7	0,08	●
84350 9	Ø 12,5	8,5	0,15	○
84351 6	Ø 12,5	8,5	0,15	●
84352 3	Ø 16	10	0,30	○
84353 0	Ø 16	10	0,30	●

NEW



84341

Schale „ZEN“
bowl
cuenco
bol



	cm	cm	litr.	
84340 0	7 x 7	2	0,03	○
84341 7	7 x 7	2	0,03	●
84342 4	9 x 9	2,5	0,06	○
84343 1	9 x 9	2,5	0,06	●
84344 8	13,5 x 13	4	0,20	○
84345 5	13,5 x 13	4	0,20	●
84346 2	16 x 15,5	4,5	0,30	○
84347 9	16 x 15,5	4,5	0,30	●

NEW



Schale „ZEN“
bowl
cuenco
bol



	cm	cm	litr.	
83729 4	18 x 10	3,5	0,10	○
83731 7	18 x 10	3,5	0,10	●
83733 1	25 x 13,5	4	0,25	○
83735 5	25 x 13,5	4	0,25	●
83737 9	30,5 x 17,5	5	0,60	○
83739 3	30,5 x 17,5	5	0,60	●



Schale „ZEN“
bowl
cuenco
bol



	cm	cm	litr.	
83714 0	17,5 x 17,5	7	0,5	○
83716 4	17,5 x 17,5	7	0,5	●

NEW



Dipschälchen „ZEN“
bowl
cuencos para salsas
ramequin



	cm	cm	litr.	
83721 8	Ø 8	1,5	0,03	○
83723 2	Ø 8	1,5	0,03	●

NEW



Schale „ZEN“
bowl
cuenco
bol



	cm	cm	litr.	
83725 6	10,5 x 10,5	3	0,06	○
83727 0	10,5 x 10,5	3	0,06	●



Schale „ZEN“
bowl
cuenco
bol



	cm	cm	litr.	
83726 3	13 x 11	3,5	0,1	○
83728 7	13 x 11	3,5	0,1	●



Schale „ZEN“
bowl
cuenco
bol



	cm	cm	litr.	
83718 8	12 x 12	4	0,2	○
83720 1	12 x 12	4	0,2	●



Schale „ZEN“
bowl
fuente alargada
plat long



	cm	cm		
83938 0	32,5 x 14	4		○
83939 7	32,5 x 14	4		●



Schale „ZEN“
bowl
cuenco
bol



	cm	cm	litr.	
83730 0	11 x 10	3	0,04	○
83732 4	11 x 10	3	0,04	●



Schale „ZEN“
bowl
cuenco
bol



	cm	↑ cm	ltr.	
83722 5	17,5 x 15,5	5,5	0,2	○
83724 9	17,5 x 15,5	5,5	0,2	●



Schale „ZEN“
bowl
cuenco
bol



	cm	↑ cm	ltr.	
83934 2	14,5 x 12,5	5	0,2	○
83935 9	14,5 x 12,5	5	0,2	●



Schale „ZEN“
bowl
cuenco
bol



	cm	↑ cm	ltr.	
83932 8	Ø 11,5	4	0,15	○
83933 5	Ø 11,5	4	0,15	●



Schale „ZEN“
bowl
cuenco
bol



	cm	↑ cm	ltr.	
83946 5	9 x 7	2,5	0,05	○
83947 2	9 x 7	2,5	0,05	●



Tablett/Teller „ZEN“
tray
bandeja
plat



	cm	↑ cm	
83940 3	Ø 28	3	○
83941 0	Ø 28	3	●



Tablett „ZEN“
tray
bandeja
plat



	cm	↑ cm	
83936 6	24 x 12,5	2	○
83937 3	24 x 12,5	2	●



Tablett „ZEN“
tray
bandeja
plat



	cm	cm	
83734 8	23 x 23,5	5,5	○
83736 2	23 x 23,5	5,5	●



Tablett, Sushiboard „ZEN“
tray, sushiboard
bandeja para sushi
plat sushi



	cm	cm	
83742 3	22,5 x 9,5	3	○
83744 7	22,5 x 9,5	3	●



Tablett, Sushiboard „ZEN“
tray, sushiboard
bandeja para sushi
plat sushi



	cm	cm	
83738 6	22 x 12	3	○
83740 9	22 x 12	3	●



83942



83943

Tablett, quadratisch „ZEN“
tray, square
bandeja cuadrada
plateau carré



	cm	cm	
83942 7	20 x 20	4,5	○
83944 1	25 x 25	5,5	○
83943 4	20 x 20	4,5	●
83945 8	25 x 25	5,5	●



Schale „ZEN“
bowl
cuenco
bol



	cm	cm	
83948 9	14 x 9	2,5	○
83949 6	14 x 9	2,5	●

FUSION



Tisch- und Buffetservierartikel präsentiert die Serie FUSION. Die Oberflächen der Artikel sind innen hoch glänzend und außen mattiert. Das besondere Design beansprucht höchste Aufmerksamkeit und bringt Speisen optimal zur Geltung. Somit werden die Speisen noch mehr in den Blickpunkt gerückt.

The FUSION presents table and buffet articles. The design and surface is unique. Mirror shiny inside, outside matt.

La línea FUSION presenta artículos para la mesa y el buffet. El diseño y el acabado son únicos, interior pulido brillante y exterior acabado en mate.

La ligne FUSION présente des articles pour la table et le buffet. Le design et la finition sont tout à fait uniques. Intérieur poli brillant et extérieur mat.



84022
Ø 11 cm

Schale „FUSION“ bowl bol plat



	☐ cm	↑ cm	ltr.
84022 5	Ø 11	7,0	0,3
84023 2	Ø 17	8,5	1,0
84024 9	Ø 20	8,0	1,2



84023

Ø 17 cm



84023



84024

Ø 20 cm



84024



84025

Tablett „FUSION“ tray bandeja plateau



	☐ cm	↑ cm
84025 6	23,5 x 7,5	2,0
84026 3	24,5 x 6,5	1,5



84025



84026



84026

HALFTONE



NEW



Löffel „HALFTONE“
spoon
cuchara
cuillère



	□ cm	↑ cm
84158 1	Ø 5,5	7

NEW



84227

Teller „HALFTONE“
plate
plato
assiette



	□ cm	↑ cm
84226 7	Ø 13,5	2,5
84227 4	Ø 16	3

NEW



84217

Schale „HALFTONE“
bowl
cuenco
bol



	□ cm	↑ cm	ltr.
84217 5	Ø 8	4	0,1
84218 2	Ø 8,5	3,5	0,05



84218



Fingerfood Löffel „HALFTONE“
party spoon
cuchara party
cuillère party



	cm	cm
84128 4	14,5 x 4,5	4,5

Schale „HALFTONE“
bowl
cuenco
bol



	cm	cm	ltr.
84129 1	7,5 x 7,5	3,5	0,05

Schale „HALFTONE“
bowl
cuenco
bol



	cm	cm	ltr.
84130 7	11,5 x 7	4	0,05
84131 4	14 x 8	4,5	0,1
84132 1	15 x 9,5	5	0,15

Schale „HALFTONE“
bowl
cuenco
bol



	cm	cm	ltr.
84133 8	17,5 x 13,5	6,5	0,35
84134 5	24 x 17,5	7,5	0,8

Schale „HALFTONE“
bol
cuenco
bol



	cm	cm	ltr.
84135 2	Ø 16,5	7,5	0,65
84136 9	Ø 19	8,5	1



Blattschale „HALFTONE“
leaf
fuente en forma de hoja
plat feuille



	cm	cm	cm
84120 8	37,5 x 15,5	4,5	
84121 5	46,5 x 21	6,5	

Blattschale „HALFTONE“
leaf
fuente en forma de hoja
plat feuille



	cm	cm	cm
84122 2	34 x 13	3	

Teller „HALFTONE“
plate
plato
assiette



	cm	cm	cm
84123 9	Ø 16	2,5	

Tablett „HALFTONE“
tray
bandeja
assiette



	cm	cm	cm
84124 6	20,5 x 12,5	3	
84125 3	24,5 x 15	3	
84127 7	34,5 x 21,5	3	
84126 0	29 x 18	4	

Schale „HALFTONE“
bowl
cuenco
bol



	cm	cm	litr.
84137 6	Ø 26	9	1,5

SINUS designed by CULTURE FORM



Charakterstark und mit dem hohen Anspruch an Funktionalität und Design präsentiert sich die Buffetserie SINUS. Die großzügigen Flächen für die Speisenpräsentation sind ausdrucksstark eingefasst und gewährleisten ein optimales Handling im Gastronomiealltag.

Buffetrange SINUS presents a modern look and feel of this endearing Gastro Norm series disguises the functional and versatile features.

SINUS: carácter, funcionalidad y diseño para el buffet. Las generosas dimensiones de las piezas SINUS se combinan para crear un montaje de buffet práctico y con personalidad apto al uso profesional a diario.

SINUS: Caractère, fonctionnalité et design. Les généreuses dimensions des pièces de la collection et leur combinaison permettent le montage d'un buffet à la fois pratique et de caractère, apte à un intensif usage quotidien.

GN Tablett „SINUS“ tray bandeja plat



GN2/4
84261



GN1/1
84230

84231



84261

	cm	GN	↑ cm	
84230 4	53 x 32,5	1/1	2	○
84231 1	53 x 16,2	2/4	2	○
84260 1	53 x 32,5	1/1	2	●
84261 8	53 x 16,2	2/4	2	●



4 Größen



0,1 ltr. bis 3,5 ltr.

Schale „SINUS“ bowl cuenco bol



	cm	↑ cm	litr.
84229 8	10,5 x 10,5	4,0	0,1
84232 8	21,0 x 21,0	9,0	1,5
84233 5	25,0 x 25,0	11,0	2,4
84234 2	28,5 x 28,5	12,5	3,5

TAO



Tisch- und Buffetservierartikel präsentiert die Serie TAO.
Die Oberflächen der Artikel sind innen hoch glänzend und außen mattiert. Das besondere Design beansprucht höchste Aufmerksamkeit und bringt Speisen optimal zur Geltung. Somit werden die Speisen noch mehr in den Blickpunkt gerückt.

The TAO presents table and buffet articles. The design and surface is unique.
Mirror shiny inside, outside matt.

La línea TAO presenta artículos para la mesa y el buffet.
El diseño y el acabado son únicos, interior pulido brillante y exterior acabado en mate.

La ligne TAO présente des articles pour la table et le buffet.
Le design et la finition sont tout à fait uniques. Intérieur poli brillant et extérieur mat.

Die Schalen sind mit rutschfesten Füßchen
ausgestattet, diese verhindern das Verrutschen.

Bowls have non-slip feet to avoid slipping.

Los boles grandes tienen pies antideslizantes.

Pieds anti-dérapants pour les bols de grande capacité





83640

Schale, rechteckig „TAO“
bowl, rectangular
cuenco
plat creux rectangulaire



	cm	↑ cm	litr.	
83639 6	32,5 x 17,5	10	1,8	○
83640 2	32,5 x 17,5	10	1,8	●



83642

Schale, quadratisch „TAO“
bowl, square
bol cuadrado
plat creux carré



	cm	↑ cm	litr.	
83642 6	30,5 x 30,5	10	3,3	○
83643 3	30,5 x 30,5	10	3,3	●



83643



83646

Schale, quadratisch „TAO“
bowl, square
bol cuadrado
plat creux carré irrégulier



	cm	↑ cm	litr.	
83645 7	33,5 x 33,5	13,5	3,8	○
83646 4	33,5 x 33,5	13,5	3,8	●



Schale „TAO“
bowl
cuenco
plat ovale creux



	cm	↑ cm	
83630 3	18,0 x 10,0	3,5	○
83633 4	25,0 x 13,5	4,5	○
83636 5	30,5 x 17,5	5,0	○
83631 0	18,0 x 10,0	3,5	●
83634 1	25,0 x 13,5	4,5	●
83637 2	30,5 x 17,5	5,0	●



TAO



83658



83660

**Schale, rund „TAO“
bowl, round
bol redondo
bol rond avec encoche**



	▣ cm	↑ cm	litr.	
83657 0	9,5 x 9	6,0	0,15	○
83660 0	14,5 x 13,5	6,0	0,4	○
83663 1	18,0 x 16,5	6,5	0,7	○
83658 7	9,5 x 9	6,0	0,15	●
83661 7	14,5 x 13,5	6,0	0,4	●
83664 8	18,0 x 16,5	6,5	0,7	●

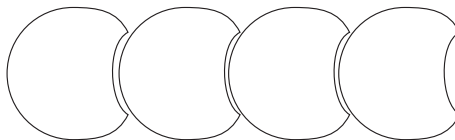

83651



83655

**Schale, rund „TAO“
bowl, round
bol redondo
bol rond coupe optique**



	▣ cm	↑ cm	litr.	
83648 8	10,5 x 10,0	6,5 / 3,0	0,07	○
83651 8	13,5 x 12,5	8,5 / 4,0	0,15	○
83654 9	17,0 x 16,0	10,5 / 4,5	0,3	○
83649 5	10,5 x 10,0	6,5 / 3,0	0,07	●
83652 5	13,5 x 12,5	8,5 / 4,0	0,15	●
83655 6	17,0 x 16,0	10,5 / 4,5	0,3	●



Tablett 83625

GLOBAL BUFFET



Schale „GLOBAL BUFFET“
bowl
cuenco
bol



	□ cm	↑ cm	ltr.	
83785 0	32,5 x 32,5	12,0	3,0	○
83786 7	35,0 x 35,0	12,5	3,5	○
83787 4	40,0 x 40,0	13,5	5,0	○
84785 9	32,5 x 32,5	12,0	3,0	●
84786 6	35,0 x 35,0	12,5	3,5	●
84787 3	40,0 x 40,0	13,5	5,0	●



Schale „GLOBAL BUFFET“
bowl
cuenco
bol



	□ cm	↑ cm	ltr.	
83799 7	∅ 25,5	13,0	3,0	○
83788 1	∅ 32,0	16,5	4,5	○
83789 8	∅ 35,0	17,0	6,0	○
83790 4	∅ 40,0	17,5	8,0	○
83779 9	∅ 25,5	13,0	3,0	●
84788 0	∅ 32,0	16,5	4,5	●
84789 7	∅ 35,0	17,0	6,0	●
84790 3	∅ 40,0	17,5	8,0	●



Schale „GLOBAL BUFFET“
bowl
cuenco
bol



	□ cm	↑ cm	ltr.
83791 1	32 x 32	12,0	2,5
83792 8	36 x 36	12,5	4,0
83793 5	40 x 40	14,0	5,5

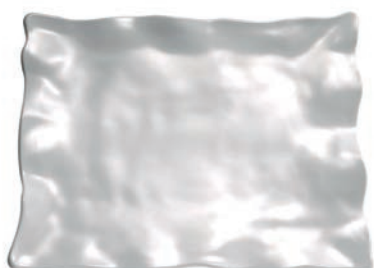

Tablett „GLOBAL BUFFET“
tray
bandeja
plat



	□ cm	↑ cm	
83794 2	30,5 x 30,5	4	quadratisch/square
83795 9	36,0 x 36,0	5	quadratisch/square
83796 6	38,5 x 29,5	5	rechteckig/rectangular
83797 3	44,0 x 34,5	5	rechteckig/rectangular

83796, 83797

EAN = 40 04 133 XXXXX X

BALANCE designed by CULTURE FORM



stapelbar
stackable
apilables
empilable



0,4 - 5,0 ltr.

Das Gleichgewicht von Eleganz und Funktionalität prägt das Design der Serie **BALANCE**. Dabei garantiert der charakteristische „Kragen“ optimales Handling und perfekte Stapelbarkeit. In Kombination mit unseren Buffetständern setzt die neue Serie Akzente auf Ihrem Buffet.

The balance of elegance and function makes the design of the range **BALANCE**. There by the characteristics of the „collar“ guarantees perfect handling and stackability. In combination with our buffet stands this new range makes the different on your buffet.

El equilibrio entre la elegancia y la funcionalidad constituyen el diseño de la gama **BALANCE**. Además las características del borde con un escalón garantizan un perfecto manejo y apilamiento.

L'équilibre entre l'élégance et la fonctionnalité constituent le design de la collection **BALANCE**. Le rebord supérieur garantit un empilage parfait et facile manipulation.



Schale „BALANCE“
bowl
cuenco
saladier



	□ cm	↑ cm	ltr.	
84040 9	Ø 14,5	9,0	0,4	○
84041 6	Ø 21,0	13,0	1,5	○
84042 3	Ø 24,5	15,0	2,5	○
84043 0	Ø 30,0	19,5	5,0	○
85040 8	Ø 14,5	9,0	0,4	●
85041 5	Ø 21,0	13,0	1,5	●
85042 2	Ø 24,5	15,0	2,5	●
85043 9	Ø 30,0	19,5	5,0	●



84042

passende
Buffet-Ständer
03622, 03623

mit Antirutsch-Füßchen
non-slip feet
con pies antideslizantes
avec pieds anti-dérapants



designed by **CULTURE FORM**

Tablett „BALANCE“
tray
bandeja
assiette

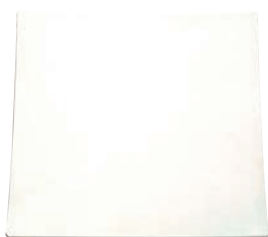

26,5 x 26,5 - 84978

	▣ cm	↑ cm	GN	
84970 9	53,0 x 32,5	3	1/1	○
84972 3	32,5 x 26,5	3	1/2	○
84974 7	53,0 x 16,2	3	2/4	○
84976 1	26,5 x 16,2	3	1/4	○
84978 5	26,5 x 26,5	3		○
84971 6	53,0 x 32,5	3	1/1	●
84973 0	32,5 x 26,5	3	1/2	●
84975 4	53,0 x 16,2	3	2/4	●
84977 8	26,5 x 16,2	3	1/4	●
84979 2	26,5 x 26,5	3		●

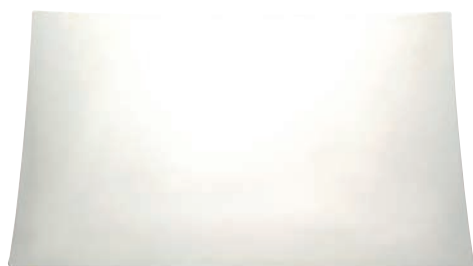

GN1/1 - 84970



GN2/4 - 84974



GN1/4 - 84977

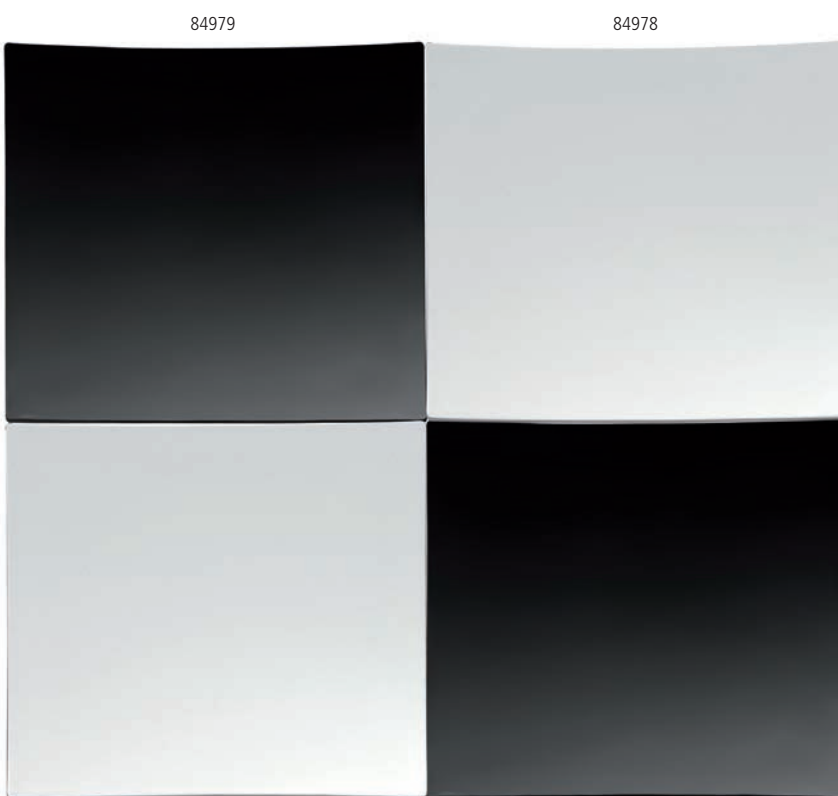

84979

84978

84978

84979



84977



Tablett „APART“
tray
bandeja
plateau



	□ cm	↑ cm	GN
83828 4	53,0 x 32,5	2,5	1/1
83830 7	32,5 x 26,5	2,5	1/2
83832 1	32,5 x 17,6	2,5	1/3
83834 5	23,0 x 23,0	2,5	
83836 9	33,0 x 33,0	2,5	
83838 3	53,0 x 53,0	2,5	



06515

Tablett, rund „APART“
tray, round
bandeja, redonda
plateau rond



	□ cm	↑ cm
83840 6	Ø 37	2,5

Einzelteile / spare parts / piezas sueltas / pièces détachées



Frischhalte-Haube / cover / campana / cloche

06515 4	Ø 33	12,5	
06516 1	Ø 33	12,5	schwarzer Griff / black handle botón negro / bouton noir
06517 8	Ø 33	12,5	mit verchromtem Griff chrom plated handle botón cromado bouton chromé



Schale, rund „APART“
bowl, round
cuenco, redonda
saladier rond



	□ cm	↑ cm	ltr.
83800 0	Ø 6,5	3,0	0,045
83802 4	Ø 10,0	4,5	0,130
83804 8	Ø 15,0	6,5	0,500
83806 2	Ø 20,0	9,0	1,200



Schale „APART“
bowl
cuenco
saladier carré



	□ cm	↑ cm	ltr.
83808 6	6,6 x 6,6	3,0	0,05
83810 9	10 x 10	4,5	0,17
83812 3	15 x 15	6,5	0,50
83814 7	20 x 20	9,0	1,60
83816 1	25 x 25	9,0	2,60



Schale „APART“
bowl
cuenco
saladier carré profond



	□ cm	↑ cm	ltr.
83818 5	25 x 25	12,5	3,8
83820 8	30 x 30	12,5	4,5



Schale „APART“
bowl
cuenco
plat rectangulaire creux



	□ cm	↑ cm	ltr.
83822 2	30 x 15	6,5	1,2
83824 6	40 x 20	6,5	2,4



GN2/4

Schale „APART“
bowl
cuenco
plat rectangulaire allongé



	□ cm	↑ cm	ltr.	GN
83826 0	53,0 x 16,2	6,5	3	2/4



SYSTEM-THEKE designed by CULTURE FORM

professionelle Lebensmittelpräsentation

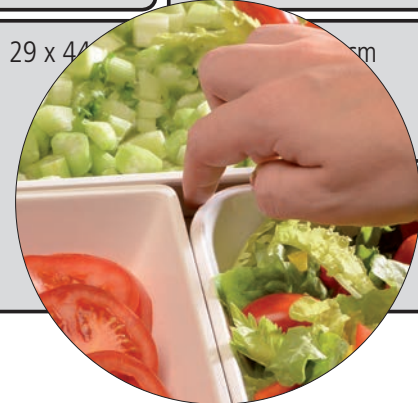

Baukasten-System



Das System umfasst 34 Schalen und Platten in den Farben schwarz und weiß. Passend zu den Schalen sind 5 transparente Deckel im Angebot. Die Vorteile: Ein flexibles Baukastensystem für Thekentieffen 70 bis 90 cm. Keine Lücken in der Theke, variable Füllmengen und einheitliche Optik. Ein größerer Radius ermöglicht ein einfaches Handling, die Elemente lassen sich leicht aus der Theke nehmen, mit Stapelnocke.

System consists of 34 bowls and trays each in black and white colour. Properly to the bowls 5 transparent covers are available. Advantages: flexible modular system for counter depth 70 to 90 cm, no gap inside the counter, variable filling quantities, uniform design. The stable edge allows an easy and fast stackle and therefore no scratching or jamming of the bowls.

El sistema para mostradores de alimentación consiste en 34 bandejas y cuencos disponibles en blanco o negro, con 5 modelos distintos de tapas transparentes. Todo son ventajas. El sistema permite combinaciones flexibles para mostradores de 70 a 90 cm de profundidad, sin huecos en el mostrador, con capacidades variables y con un diseño elegante y uniforme. Las esquinas dejan el espacio suficiente para que se pueda quitar y poner los recipientes con fácil manejo, sin roces ni ralladuras.

Ce système élégant et pratique de présentation pour vitrines d'alimentation comprend 34 références de plats et bols en noir et en blanc. Et 5 couvercles transparents. Avantages: système modulaire flexible pour comptoirs prof. 70-90 cm, sans espaces vides et en même temps commodité de préhension grâce à la forme des angles des récipients, pour les retirer ou remettre facilement.

Deckel transparent, mit Löffelaussparung
cover, transparent, with notched for spoons
tapa transparente, con espacio para la cuchara
couvercle transparent avec encoche pour la cuillère



		matches
84054	6	22 x 14,5
84058	4	22 x 22,0
84061	4	29 x 22,0
84065	2	29 x 29,0
84068	3	44 x 22,0
		84050-84053, 84150-84153
		84055-84057, 84155-84157
		84059-84060, 84159-84160
		84062-84064, 84162-84164
		84066-84067, 84166-84167



Tablett 84050, 84062, 84066, 84069



quadratisch
und
rechteckig



„SYSTEM-THEKE“
System-counter
Sistema para mostrador
Système-Comptoir



	□ cm	↑ cm	ltr.	
84050 8	22 x 14,5	2	-	○
84051 5	22 x 14,5	4	0,7	○
84052 2	22 x 14,5	6	1,0	○
84053 9	22 x 14,5	9	1,7	○
84055 3	22 x 22,0	4	1,0	○
84056 0	22 x 22,0	6	1,8	○
84057 7	22 x 22,0	9	3,0	○
84073 7	28 x 21,0	4	1,5	○
84059 1	29 x 22,0	4	1,3	○
84060 7	29 x 22,0	6	2,1	○
84062 1	29 x 29,0	2	-	○
84063 8	29 x 29,0	4	1,5	○
84064 5	29 x 29,0	6	3,0	○
84076 8	42 x 28,0	4	3,0	○
84066 9	44 x 22,0	2	-	○
84067 6	44 x 22,0	4	2,0	○
84069 0	44 x 29,0	2	-	○



Tablett 84150, 84162, 84166, 84169



rechteckig
und
quadratisch



	□ cm	↑ cm	ltr.	
84150 5	22 x 14,5	2	-	●
84151 2	22 x 14,5	4	0,7	●
84152 9	22 x 14,5	6	1,0	●
84153 6	22 x 14,5	9	1,7	●
84155 0	22 x 22,0	4	1,0	●
84156 7	22 x 22,0	6	1,8	●
84157 4	22 x 22,0	9	3,0	●
84173 4	28 x 21,0	4	1,5	●
84159 8	29 x 22,0	4	1,3	●
84160 4	29 x 22,0	6	2,1	●
84162 8	29 x 29,0	2	-	●
84163 5	29 x 29,0	4	1,5	●
84164 2	29 x 29,0	6	3,0	●
84176 5	42 x 28,0	4	3,0	●
84166 6	44 x 22,0	2	-	●
84167 3	44 x 22,0	4	2,0	●
84169 7	44 x 29,0	2	-	●

GASTRONORMBEHÄLTER

GASTRONORM-CONTAINER / FUENTE GASTRONORM / BACS GASTRONORME



- Melamin, elfenbein - weiß
- mit Stapelnocke
- superleichtes Stapeln und Entstapeln

- melamin, ivory - white
- with notching edge
- clean ladling and pouring
- not recommend in cookware

- melamina, blanco
- con borde para apilamiento
- muy fáciles de apilar y desapilar
- no recomendado para su uso en marmitas u ollas

- mélamine, blanc ivoirie, encoche pour une louche, faciles à empiler et sésempiler
- usage non recommandé pour marmites ou casseroles



GN-Behälter „HIGHLINE“
GN-container
cubetas GN
bacs Gastronorme



extrem bruchsticher, glänzende und harte Oberfläche, tiefkühlfest, keinen Temperaturschocks unterziehen, nicht auf heißen Flächen liegen lassen, elfenbein - weiß

durable, top quality, hard and glossy surface, avoid thermal shocks, do not leave on hot surfaces, ivory - white

duradera, alta calidad, superficie brillante y resistente. Hay que evitar los cambios térmicos bruscos. No apoyar en superficies calientes, blanco

durable, haute qualité, surface brillante et résistante. Eviter les chocs thermiques et ne pas poser sur une surface chaude, blanc ivoirie



83762



83763

	cm	mm	GN	litr.
83772 0	53,0 x 32,5	65	1/1	7,10
83770 6	35,0 x 32,5	65	2/3	4,60
83768 3	32,5 x 26,5	65	1/2	3,40
83766 9	53,0 x 16,2	65	2/4	3,00
83764 5	32,5 x 17,6	65	1/3	2,00
83762 1	26,5 x 16,2	65	1/4	1,35
83760 7	17,6 x 16,2	65	1/6	0,80
83773 7	53,0 x 32,5	100	1/1	11,0
83769 0	32,5 x 26,5	100	1/2	5,50
83765 2	32,5 x 17,6	100	1/3	3,15
83763 8	26,5 x 16,2	100	1/4	2,20
83761 4	17,6 x 16,2	100	1/6	1,25

**HOT
PRICE**

GN-Behälter „ECOLINE“
GN container
GN cubeta superior
GN bac supérieur



mit Stapelnocke
 with notching edge
 con borde marcado para el apilado
 avec rebord pour l'empilage



GN1/1
 83759 65 mm
 84300 100 mm



GN1/2
 83756 65 mm
 84307 100 mm



GN2/4
 83755 65 mm
 84302 100 mm



GN1/3
 83752 65 mm
 84309 100 mm



GN1/4
 83751 65 mm
 84304 100 mm



GN1/6
 83748 65 mm
 84311 100 mm



GN1/6
 83749 65 mm
 84305 100 mm

GN2/4
 83754 65 mm
 84308 100mm



	cm	mm	GN	litr.	
83759 1	53,0 x 32,5	65	1/1	7,10	○
83757 7	32,5 x 26,5	65	1/2	3,40	○
83755 3	53,0 x 16,2	65	2/4	3,00	○
83753 9	32,5 x 17,6	65	1/3	2,00	○
83751 5	26,5 x 16,2	65	1/4	1,35	○
83749 2	17,6 x 16,2	65	1/6	0,80	○
83758 4	53,0 x 32,5	65	1/1	7,10	●
83756 0	32,5 x 26,5	65	1/2	3,40	●
83754 6	53,0 x 16,2	65	2/4	3,00	●
83752 2	32,5 x 17,6	65	1/3	2,00	●
83750 8	26,5 x 16,2	65	1/4	1,35	●
83748 5	17,6 x 16,2	65	1/6	0,80	●
84300 4	53,0 x 32,5	100	1/1	10,6	○
84301 1	32,5 x 26,5	100	1/2	4,7	○
84302 8	53,0 x 16,2	100	2/4	4,3	○
84303 5	32,5 x 17,6	100	1/3	2,7	○
84304 2	26,5 x 16,2	100	1/4	1,9	○
84305 9	17,6 x 16,2	100	1/6	1,0	○
84306 6	53,0 x 32,5	100	1/1	10,6	●
84307 3	32,5 x 26,5	100	1/2	4,7	●
84308 0	53,0 x 16,2	100	2/4	4,3	●
84309 7	32,5 x 17,6	100	1/3	2,7	●
84310 3	26,5 x 16,2	100	1/4	1,9	●
84311 0	17,6 x 16,2	100	1/6	1,0	●

CASCADE

designed by CULTURE FORM



Gastronorm - size

Gastronorm - Medidas exteriores

Gastronorme - Diensions extérieures

Das **CASCADE** System
The **CASCADE** system
El sistema **CASCADE**
Le système **CASCADE**

Tablett kann als Deckel eingesetzt werden!
tray is also useable as a cover!
¡La bandeja se puede usar como tapa!
Le plat s'utilise aussi comme couvercle



**Schale „CASCADE“
bowl
cuenco
bol**



GN1/2 - 83960



GN2/4 - 83961



GN1/4 - 83962

	☐ cm	↑ cm	GN	ltr.
83960 1	32,5 x 26,5	7,5	1/2	3,65
83961 8	53,0 x 16,2	7,5	2/4	3,65
83962 5	26,5 x 16,2	7,5	1/4	1,50
83963 2	28,5 x 25,5	7,5		2,90



28,5 x 25,5
83963



83965



83966



83967



83964

**Tablett „CASCADE“
tray
bandeja
plat**



	☐ cm	↑ cm	matches	GN
83965 6	32 x 27	2,4	83960	1/2
83966 3	52 x 16	2,4	83961	2/4
83967 0	26 x 16	2,4	83967	1/2
83964 9	28 x 25	2,4	83963	

Tablett kann als Deckel eingesetzt werden!
tray is also useable as a cover!

¡La bandeja se puede usar como tapa!
Le plat s'utilise aussi comme couvercle



rutschfest stapeln

FLOAT designed by EsserDesign



- inklusive Deckel stapelbar
- Schalenboden fixiert sich auf dem Deckel
- rutschfest (Antirutschfüßchen)

- with spoon and cover stackable
- non-slip feet

- apilables
- con tapa apilable
- la base se fija a la tapa
- apilado estable (pies anti-deslizantes)

- avec couvercle qui permet un empilage parfait
- le pied du bol supérieur s'encadre dans le couvercle
- anti-dérapant



SAN
KUNSTSTOFF



Deckel, transparent, mit Löffelaussparung
 cover, transparent, with notched for spoons
 tapa transparente, con espacio para la cuchara
 couvercle transparent avec encoche pour la louche



83923



83924

Tablett GN „FLOAT“
tray GN
bandeja GN
plateau GN



	cm	↑ cm	GN	
83923 6	53,0 x 32,5	3	1/1	○
83925 0	32,5 x 26,5	3	1/2	○
83924 3	53,0 x 32,5	3	1/1	●
83926 7	32,5 x 26,5	3	1/2	●



0,03 ltr. - 1,90 ltr



Schale, rund „FLOAT“
bowl, round
cuenco, redondo
saladier rond



	cm	↑ cm	ltr.	
83900 7	∅ 5,5	3,0	0,03	○
83902 1	∅ 9,0	4,5	0,15	○
83904 5	∅ 13,0	6,5	0,45	○
83906 9	∅ 15,0	7,5	0,70	○
83908 3	∅ 20,5	10,0	1,90	○
83901 4	∅ 5,5	3,0	0,03	●
83903 8	∅ 9,0	4,5	0,15	●
83905 2	∅ 13,0	6,5	0,45	●
83907 6	∅ 15,0	7,5	0,70	●
83909 0	∅ 20,5	10,0	1,90	●



0,03 ltr. - 4,70 ltr



Schale „FLOAT“
bowl
cuenco
saladier



	cm	↑ cm	ltr.	
83910 6	5,5 x 5,5	3,0	0,03	○
83912 0	9,0 x 9,0	4,5	0,16	○
83914 4	12,5 x 12,5	6,0	0,50	○
83916 8	19 x 19	9,5	1,90	○
83918 2	25 x 25	12,0	4,70	○
83911 3	5,5 x 5,5	3,0	0,03	●
83913 7	9,0 x 9,0	4,5	0,16	●
83915 1	12,5 x 12,5	6,0	0,50	●
83917 5	19 x 19	9,5	1,90	●
83919 9	25 x 25	12,0	4,70	●



83920



83921
83922

Deckel „FLOAT“, mit Löffelaussparung
cover, with notched for spoons
tapa, con espacio para la cuchara
couvercle, avec encoche pour la louche



	cm	↑ cm	matches
83920 5	∅ 20,5	1,3	83908, 83909
83921 2	19 x 19	1,3	83916, 83917
83922 9	25 x 25	1,3	83918, 83919



Buffet-Gestell „FLOAT SMALL“
buffet stand
soporte bufé
support buffet



Metall verchromt, für 3 Schalen Nr. 83916, 83917
 metal chrome plated, for 3 bowls no. 83916, 83917
 metal cromado, para 3 cuencos N° 83916, 83917
 métal chromé, pour 3 coupelles 83916, 83917

	▣ cm	↑ cm
33241 6	55,5 x 19	15,5



Buffet-Gestell „FLOAT BIG“
buffet stand
soporte bufé
support buffet



Metall verchromt, für 3 Schalen Nr. 83914, 83915, für 1 Schale Nr. 83918, 83919
 metal chrome plated, for 3 bowls no. 83914, 83915, for 1 bowl no. 83918, 83919
 metal cromado, para 3 cuencos N° 83914, 83915, para 1 cuenco N° 83918, 83919
 métal chromé, pour 3 coupelles 83914, 83915 ou 1 bol 83918, 83919

	▣ cm	↑ cm
33242 3	39 x 39	17



- vielseitig einsetzbar
- rutschfest

- multi usable
- non-slip

- versátil
- antideslizante

- utilisations multiples
- anti-dérapant

CLASSIC WAVE designed by EsserDesign



Wellen - Dekor
wave - decor

vielseitig einsetzbar- ideal für den Einsatz am Buffet, Theken, Vorspeisenwagen

versatile - ideal for use on buffets, salad bars or appetizer trays

versátil, ideal para uso en bufés, mostradores, bandejas de aperitivos.

utilisations multiples, anti-dérapant

Schale, oval „CLASSIC WAVE“
owl, oval
fuelle, ovalada
plat ovale



	☐ cm	↑ cm	ltr.
83875 8	27 x 17	4,0	0,80
83876 5	34 x 21	4,5	1,30
83877 2	47 x 29	5,0	3,20



PURE

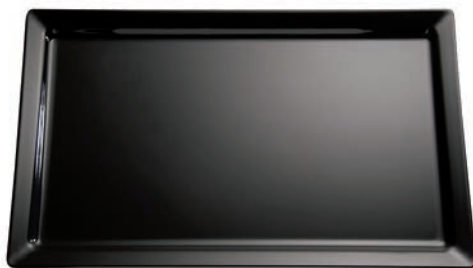
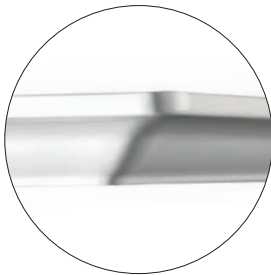

Tablett „PURE“
tray
bandeja
plat



	▣ cm	↑ cm	GN	
83401 9	53,0 x 32,5	3	1/1	○
83480 4	32,5 x 26,5	3	1/2	○
83481 1	32,5 x 17,6	3	1/3	○
83588 7	35,4 x 32,5	3	2/3	○
83482 8	26,5 x 16,2	3	1/4	○
83433 0	53,0 x 16,2	3	2/4	○
83882 6	65,0 x 26,5	3		○
83597 9	40 x 30	3	Bäcker-Maß	○
83598 6	60 x 20	3	Bäcker-Maß	○
83599 3	60 x 40	3	Bäcker-Maß	○
83592 4	40 x 30	3	Bäcker-Maß	●
83593 1	60 x 20	3	Bäcker-Maß	●
83594 8	60 x 40	3	Bäcker-Maß	●
83479 8	53,0 x 32,5	3	1/1	●
83490 3	32,5 x 26,5	3	1/2	●
83491 0	32,5 x 17,6	3	1/3	●
83589 4	35,4 x 32,5	3	2/3	●
83492 7	26,5 x 16,2	3	1/4	●
83434 7	53,0 x 16,2	3	2/4	●



Tablett, Sushiplatte „PURE“
 tray
 bandeja
 plat sushi



	▣ cm	↑ cm	
83625 9	31,0 x 10,5	2	○
83417 0	30,0 x 21,0	3	○
83403 3	35,5 x 18,0	3	○
83402 6	53,0 x 18,0	3	○
83626 6	31,0 x 10,5	2	●
83483 5	53,0 x 18,0	3	●



Tablett quadratisch „PURE“
 tray square
 bandeja cuadradas
 plateau carrés



	▣ cm	↑ cm	
83418 7	18,0 x 18,0	3	○
83407 1	21,0 x 21,0	3	○
83406 4	26,5 x 26,5	3	○
83405 7	37,0 x 37,0	3	○
83404 0	51,0 x 51,0	3	○
83400 2	51,0 x 51,0	3	●



Tablett/Teller „PURE“
 tray
 bandeja
 plat



	▣ cm	↑ cm	
83884 0	Ø 31	2,5	○
83869 7	Ø 38	2,5	○
83886 4	Ø 41	2,5	○
83484 2	Ø 51	2,5	○



Schale / Pastateller „PURE“
 bowl
 cuenco
 assiette creuse



	▣ cm	↑ cm	ltr.	
83412 5	Ø 32,0	7,5	1,5	○
83411 8	Ø 45,5	9,0	1,7	○



oval

Teller oval „PURE“
 plate oval
 plato oval
 asslette ovale



	▣ cm	↑ cm	
83517 7	27,0 x 19,5	3	○
83493 4	30,5 x 22,5	3	○
83494 1	38,0 x 28,0	3	○



**Schale „PURE“
bowl
cuenco
bol**



	□ cm	↑ cm	litr.	
83450 7	Ø 5,5	4,0	0,02	○
83419 4	Ø 9,5	4,5	0,09	○
83453 8	Ø 13,0	6,5	0,30	○
83455 2	Ø 15,0	7,5	0,45	○
83415 6	Ø 20,0	10,5	1,25	○
83451 4	Ø 5,5	4,0	0,02	●
83452 1	Ø 9,5	4,5	0,09	●
83454 5	Ø 13,0	6,5	0,30	●
83456 9	Ø 15,0	7,5	0,45	●
83457 6	Ø 20,0	10,5	1,25	●



**Schale „PURE BICOLOR“
bowl
cuenco
bol**



	□ cm	↑ cm	litr.	
84414 8	9,0 x 9,0	4,0	0,14	◐
84410 0	12,5 x 12,5	6,5	0,40	◐
84409 4	19,0 x 19,0	9,0	1,50	◐
84408 7	25,0 x 25,0	12,0	3,80	◐
84415 5	9,0 x 9,0	4,0	0,14	◑
84416 2	12,5 x 12,5	6,5	0,40	◑
84417 9	19,0 x 19,0	9,0	1,50	◑
84418 6	25,0 x 25,0	12,0	3,80	◑
84420 9	9,0 x 9,0	4,0	0,14	◒
84421 6	12,5 x 12,5	6,5	0,40	◒
84422 3	19,0 x 19,0	9,0	1,50	◒
84423 0	25,0 x 25,0	12,0	3,80	◒



**Schale „PURE COLOR“
bowl
cuenco
bol**



	□ cm	↑ cm	litr.	
83414 9	9,0 x 9,0	4,0	0,14	○
83410 1	12,5 x 12,5	6,5	0,40	○
83409 5	19,0 x 19,0	9,0	1,50	○
83408 8	25,0 x 25,0	12,0	3,80	○
83466 8	9,0 x 9,0	4,0	0,14	●
83467 5	12,5 x 12,5	6,5	0,40	●
83468 2	19,0 x 19,0	9,0	1,50	●
83469 9	25,0 x 25,0	12,0	3,80	●
83568 9	9,0 x 9,0	4,0	0,14	◐
83570 2	12,5 x 12,5	6,5	0,40	◐
83572 6	19,0 x 19,0	9,0	1,50	◐
83574 0	25,0 x 25,0	12,0	3,80	◐
83569 6	9,0 x 9,0	4,0	0,14	◑
83571 9	12,5 x 12,5	6,5	0,40	◑
83573 3	19,0 x 19,0	9,0	1,50	◑
83575 7	25,0 x 25,0	12,0	3,80	◑

NEW



83600

**Deckel „PURE“, mit Löffelaussparung
cover, with notched for spoons
tapa, con espacio para la cuchara
couvrele, avec encoche pour la louche**



	cm	cm	matches
83600 6	19 x 19	1,5	84410, 84417, 84422, 83409 83572, 83468, 83573, 84429
83601 3	25 x 25	1,5	84408, 84418, 84423, 83469, 83574, 83575, 83408, 84430

designed by **sieger design**



**Tablett „FRAMES“
tray
bandeja
plat**



	cm	cm	GN	
84046 1	53,0 x 32,5	2	1/1	○
84047 8	32,5 x 26,5	2	1/2	○
84048 5	32,5 x 17,6	2	1/3	○



**Tablett „PURE COLOR“
tray
bandeja
plat**



	cm	cm	GN	
83560 3	53,0 x 32,5	3	1/1	●
83562 7	32,5 x 26,5	3	1/2	●
83564 1	53,0 x 18,0	3		●
83566 5	35,5 x 18,0	3		●
83561 0	53,0 x 32,5	3	1/1	●
83563 4	32,5 x 26,5	3	1/2	●
83565 8	53,0 x 18,0	3		●
83567 2	35,5 x 18,0	3		●



**GN Tablett „PURE GRANIT“
GN tray
GN bandeja
GN plateau**



	cm	cm	GN
84440 7	53,0 x 32,5	3	1/1
84441 4	32,5 x 26,5	3	1/2
84442 1	53,0 x 16,2	3	2/4

Granitoptik



**Schale „PURE GRANIT“
bowl
cuenco
bol**



	cm	cm	ltr.
84429 2	19 x 19	9	1,5
84430 8	25 x 25	12	3,8

1,5 ltr.
3,8 ltr.

**Schale „PURE“
bowl
cuenco
bol**



83497
0,8 ltr.



83498
1,5 ltr.



83499
2,4 ltr.

	cm	cm	litr.
83497 2	22,5 x 15,5	7,5	0,8
83498 9	38,5 x 15,5	7,5	1,5
83499 6	51,0 x 15,5	7,5	2,4



30120



30122

**Tablett „PURE“
tray
bandeja
plat**



Edelstahl matt poliert, passend für Melamin-Schalen 83414 oder 83466
stainless steel satin polished finish, for melamin bowls 83414 or 83466
acero inoxidable mate, apta para cuencos de melamina 83414 o 83466
inox mat, concient pour bols mélamine 83414 et 83466

	cm	
30120 7	20 x 11	für 2 Schalen / for 2 bowls apta para 2 cuencos / pour 2 bols
30122 1	20 x 20	für 4 Schalen / for 4 bowls apta para 4 cuencos / pour 4 bols
30121 4	29 x 20	für 6 Schalen / for 6 bowls apta para 6 cuencos / pour 6 bols



30121
Tablett

83414
Schale



83414
Schale

30120
Tablett



Menage „PURE“
menage
conjunto aperitivo
set apéritif



5-teilig: 1 Ständer, Edelstahl matt poliert + 4 Melamin-Schalen, weiß (Nr. 83414)
 5 pcs. set: 1 stainless stand satin polished finish + 4 square white bowls (No. 83414)
 5 unidades: 1 soporte, acero inoxidable mate + 4 cuencos de melamina blancos redondos (N° 83414)
 5 pièces: 1 support inox mat + 4 coupelles rondes mélamine blanche ref 83414)

	☐ cm	↑ cm
09923 4	17 x 17	16



Menage „PURE“
menage
conjunto aperitivo
set apéritif



4-teilig: 1 Ständer, Edelstahl matt poliert + 3 Melamin-Schalen, weiß (Nr. 83419)
 4 pcs. set: 1 stainless stand satin polished finish + 3 white bowls (No. 83419)
 4 unidades: 1 soporte, acero inoxidable mate + 3 cuencos de melamina blancos redondos (N° 83419)
 4 pièces: 1 support inox mat + 3 coupelles rondes mélamine blanche ref 83419)

	☐ cm	↑ cm
09924 1	14 x 14	16

drehbar /
schwenkbar

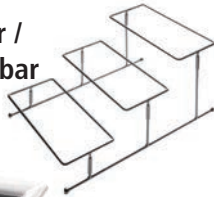

Serviergestell „FLEXIBEL“
servicing stand
expositor
présentoir



3-stufig „beweglich / drehbar“, platzsparend zerlegbar
 3 tier, flexible frame, space saving
 3 alturas, marco flexible, ahorra espacio
 3 hauteurs, cadre souple, gagne de la place

	☐ cm	↑ cm
33243 0	45,5 x 32	21,5

passende Tablett
83403, 83566 und 83567



Serviergestell „S-PURE“
servicing stand
soporte
support buffet



für 3 Tablett **quadratisch** 83407 oder 83418
 for 3 trays **square** 83407 or 83418
 para 3 bandeja **cuadradas** 83407 o 83418
 pour 3 plats **carrés** 83407 ou 83418

	☐ cm	↑ cm
33226 3	29 x 17	41

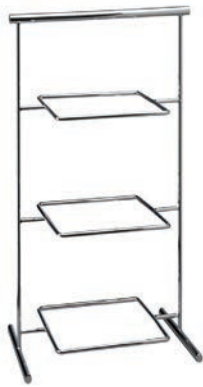

Serviergestell „M-PURE“
servicing stand
soporte
support buffet



für 3 Tablett **quadratisch** 83406 oder 83407
 for 3 trays **square** 83406 or 83407
 para 3 bandejas **cuadradas** 83406 o 83407
 pour 3 plats **carrés** 83406 o 83407

	☐ cm	↑ cm	matches
33227 0	33 x 21	44	83406, 83407



Serviergestell „L-PURE“
servicing stand
soporte
support buffet



für 3 Tablett **rechteckig** 83417
 for 3 trays **rectangular** 83417
 para 3 bandejas **rectangulares** 83417
 pour 3 plats **rectangulaires** 83417

	☐ cm	↑ cm	matches
33228 7	37 x 21	44	83417

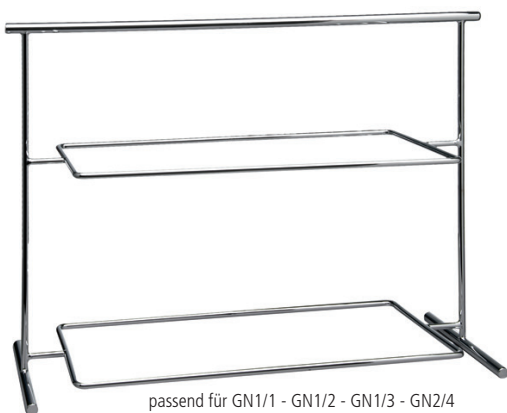

passend für GN1/1 - GN1/2 - GN1/3 - GN2/4

Serviergestell GN „XL-PURE“
servicing stand GN
soporte GN
support buffet GN



Passend für Tablett PURE GN1/1, GN1/2, GN1/3, GN2/4
 suitable for tray GN1/1, GN1/2, GN1/3, GN2/4
 aptas para bandejas GN1/1, GN1/2, GN1/3, GN2/4
 convient pour les plats GN1/1, GN1/2, GN1/3, GN2/4

	☐ cm	↑ cm	matches
33222 5	63 x 27	44,5	all PURE GN-trays



37 x 37 cm
83405

72 cm

Serviergestell „XXL-PURE“
servicing stand
soporte
support buffet



für 3 Tablett **quadratisch** 83405 (37 x 37 cm)
 for 3 trays **square** 83405 (37 x 37 cm)
 para 3 bandejas **cuadradas** 83405 (37 x 37 cm)
 pour 3 plats **carrés** 83405 (37 x 37 cm)

	☐ cm	↑ cm	matches
33234 8	45 x 37	72	83405

BASKET

designed by CULTURE FORM



Gastronorm - Außenmaße
 Gastronorm - size
 Gastronorm - medidas exteriores
 Gastronorme - Diensions extérieures



GN1/2 - 84000



GN1/4 - 84004



GN2/4 - 84003



stapelbar
stackable

Schale „BASKET“
bowl
cuenco
bol



	□ cm	↑ cm	GN	ltr.	
84000 3	32,5 x 26,5	8,5	1/2	3,50	○
84002 7	53,5 x 16,2	8,5	2/4	3,20	○
84004 1	26,5 x 16,2	8,5	1/4	1,40	○
84006 5	25,0 x 25,0	10		2,80	○
84001 0	32,5 x 26,5	8,5	1/2	3,50	●
84003 4	53,5 x 16,2	8,5	2/4	3,20	●
84005 8	26,5 x 16,2	8,5	1/4	1,40	●
84007 2	25,0 x 25,0	10		2,80	●

NATURAL COLLECTION



Blattschale „NATURAL COLLECTION“ leaf fuente en forma de hoja plat feuille



84083, 84086



84084, 84087

	cm	cm	
84083 6	40 x 18,5	3,5	○
84086 7	52 x 25,0	4,0	○
84084 3	40 x 18,5	3,5	●
84087 4	52 x 25,0	4,0	●
84085 0	40 x 18,5	3,5	●
84088 1	52 x 25,0	4,0	●



84085, 84088



84080



84081



84082

Palmblattschale „NATURAL COLLECTION“ bowl fuente en forma de hoja de palmera plat feuille de palme



	cm	cm	litr.	
84080 5	40 x 18,5	10	1,8	○
84081 2	40 x 18,5	10	1,8	●
84082 9	40 x 18,5	10	1,8	●

stapelbar, mit Löffelablage
stackable, for spoons
apilable, práctico para cubiertos de servicio
empilable, pratique pour déposer les couverts

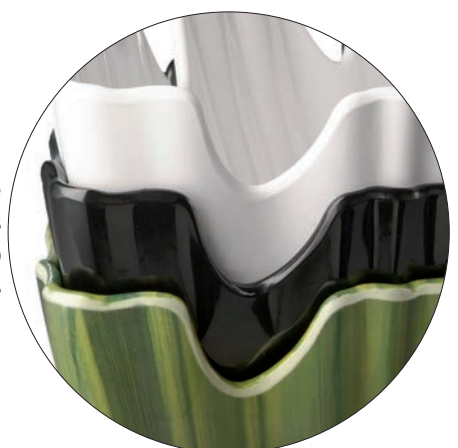



83864



83863



83862

Blattschale „NATURAL COLLECTION“
leaf
fuente en forma de hoja
plat feuille



	cm	cm	
83864 2	34,5 x 8	2,5	○
83863 5	34,5 x 8	2,5	●
83862 8	34,5 x 8	2,5	●



Blattschale „NATURAL COLLECTION“
leaf
fuente en forma de hoja
plat feuille



	cm	cm	
83435 4	36 x 16	3,0	○
83438 5	45 x 24	3,0	○
83441 5	53 x 29	3,5	○
83436 1	36 x 16	3,0	●
83439 2	45 x 24	3,0	●
83442 2	53 x 29	3,5	●
83437 8	36 x 16	3,0	●
83440 8	45 x 24	3,0	●
83443 9	53 x 29	3,5	●



Palmbattschale „NATURAL COLLECTION“
tray
fuente en forma de hoja de palmera
plat feuille de palme



	cm	cm	
83871 0	27 x 27	4,5	○
83444 6	35 x 34	4,5	○
83873 4	42 x 42	4,5	○
83872 7	27 x 27	4,5	●
83445 3	35 x 34	4,5	●
83874 1	42 x 42	4,5	●
83865 9	27 x 27	4,5	●
83446 0	35 x 34	4,5	●
83866 6	42 x 42	4,5	●



Palmbattschale „NATURAL COLLECTION“
bowl
fuente en forma de hoja de palmera
plat feuille de palme



	cm	cm	litr.	
83447 7	Ø 30	10,0	1,5	○
83896 3	Ø 35	12,5	4,5	○
83448 4	Ø 30	10,0	1,5	●
83895 6	Ø 35	12,5	4,5	●
83449 1	Ø 30	10,0	1,5	●
83894 9	Ø 35	12,5	4,5	●

CASUAL



2 Größen

Schälchen „CASUAL MINI“
bowl
bol
bol mini



	□ cm	↑ cm	ltr.	
83880 2	Ø 6	2,5	0,02	○
83881 9	Ø 7,5	3,5	0,05	○



5 Größen

Schale „CASUAL MAXI“
bowl
cuenco
bol



	□ cm	↑ cm	ltr.	
83696 9	Ø 10	4,5	0,15	○
83698 3	Ø 12	5,5	0,25	○
83700 3	Ø 14	6,5	0,50	○
83704 1	Ø 20	9,2	1,80	○
83702 7	Ø 23	10,5	2,50	○
83697 6	Ø 10	4,5	0,15	●
83699 0	Ø 12	5,5	0,25	●
83701 0	Ø 14	6,5	0,50	●
83705 8	Ø 20	9,2	1,80	●
83703 4	Ø 23	10,5	2,50	●



passender Ø 20 cm Deckel 83920
für Schalen 83704 und 83705



6 Größen

Dip-Schälchen „CASUAL“
bowl
cuencos para salsas
ramequin



	□ cm	↑ cm	ltr.	
83780 5	Ø 6,0	3,7	0,04	○
83781 2	Ø 7,0	3,7	0,05	○
83782 9	Ø 7,8	4,0	0,08	○
83783 6	Ø 8,5	4,5	0,11	○
83784 3	Ø 9,8	4,5	0,14	○
83798 0	Ø 6,0	3,7	0,04	●
83777 5	Ø 6,0	3,5	0,03	●



Serviergestell „CASUAL“
servicing stand
expositor
présentoir



ohne Schalen / Körbe
 without bowls / baskets
 sin bols / cestas
 sans bols / corbeilles



Schale - Ø 14 cm
 83700



Schale - Ø 14 cm
 83701

4 x Ø 14 cm

Gestell
 4 x Ø 14 cm
 33244



Körbe - Ø 20 cm
 50605, 50606 oder 50607



Schale - Ø 20 cm
 83705 oder 83704



Gestell
 4 x Ø 20 cm
 33245



4 x Ø 14 cm

Gestell
 4 x Ø 20 cm
 33245

	□ cm	↑ cm	
33244 7	Ø 35	46	4 x Ø 14
33245 4	Ø 48	49	4 x Ø 20

Etagère „CASUAL“
 etagère
 expositor de bombones o bocaditos
 présentoir à mignardises



inkl. Schild
 incl. sign
 incluida la inscripción
 avec inscription

	∅ cm	↑ cm	
34248 4	Ø 31 - 41 - 51	55	3-stufig / 3-tier 3 niveles / 3 étages
34247 7	Ø 31 - 41	35	2-stufig / 2-tier 2 niveles / 2 étages



34248

3-stufig / 3-tier

einsteckbares Edstahlschild,
 beschriftbar (Schild ist nicht beschriftet)



34247

2-stufig / 2-tier



Fischplatte „CASUAL“
 fish platter
 fuente pescado
 plat à poisson



	∅ cm	↑ cm
83995 3	28,0 x 17,0	2,5
83997 7	48,0 x 22,5	2,5



Fischschale „CASUAL“
 fish bowl
 cuenco para pescado
 plat creux à poisson



	∅ cm	↑ cm	litr.
83991 5	24 x 27	5,5	0,6
83993 9	30 x 35	7,5	1,2

0,6 ltr.
 1,2 ltr.

Fischplatte „BIG“
fish plate
cuenco para pescado
plat creux à poisson



	□ cm	↑ cm	ltr.
83996 0	58,5 x 28,0	5,5	2,0



Schale „BOAT“
bowl
cuenco
bol



	□ cm	↑ cm	ltr.
84037 9	21,5 x 13,0	5,0	0,45
84038 6	29,0 x 18,5	7,5	1,50



84037

Tablett / Sushiboard
sushi board
bandeja
plateau



	□ cm	↑ cm	
84980 8	24,0 x 10,5	2,5	○
84981 5	24,0 x 10,5	2,5	●



84980

Schale „LEAF“
bowl
cuenco
bol



	□ cm	↑ cm	ltr.	
84200 7	42,0 x 19,5	6,5	1,0	○
84202 1	50,0 x 23,0	7,5	1,5	○
84201 4	42,0 x 19,5	6,5	1,0	●
84203 8	50,0 x 23,0	7,5	1,5	●



designed by EsserDesign

**Schale „SCANTIC“
bowl
cuenco
bol**



84221

	cm	cm	litr.
84221 2	26,5 x 10,5	6,5	1
84222 9	53,0 x 10,5	6,5	2

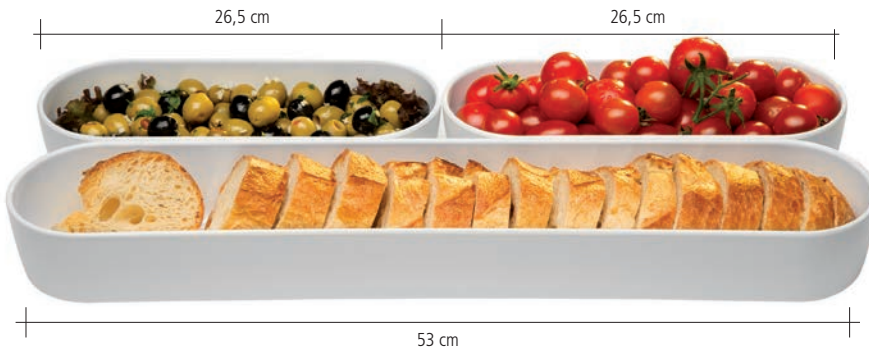

84215



84216

**Schale „CASUAL“
bowl
cuenco
bol**



	cm	cm	litr.
84215 1	Ø 10	6,5 / 8,5	0,2
84216 8	Ø 12	7,5 / 9,5	0,3



84210



84211

**Schale „PALMA“
bowl
cuenco
bol**



mit rutschfestem Boden
with non-slip bottom
con pies antideslizantes
pieds anti-dérapants

	cm	cm	litr.
84210 6	Ø 14	6,5	0,60
84211 3	Ø 13	10,5	0,75

**Dipschale „CASUAL“
bowl
cuenco
plateau**



	cm	cm
84220 5	29,0 x 9,0	3,0



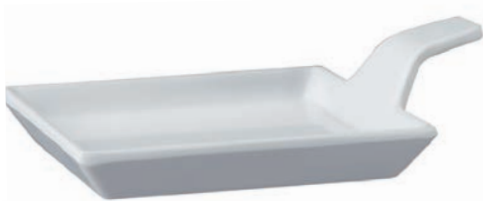

83878



83879

Fingerfood-Teller „FLYING BUFFET“
plate
plato
assiette



	cm	↑ cm	
83878 9	9,5 x 9,5	1,5 / 3,5	○
83879 6	9,5 x 9,5	1,5 / 3,5	●

Einzelteile / spare parts / piezas sueltas / pièces détachées

Edelstahl Tablett / stainless steel platter / bandeja / plateau

11119 6 53 x 32,5

Tablett „APART“ / tray / bandeja / plateau

83828 4 53,0 x 32,5 2,5

Schale „FLOAT“ / bowl / cuenco / saladier

83912 0 9,0 x 9,0 4,5 ○ 0,16

Schale „FLOAT“ / bowl / cuenco / saladier

83913 7 9,0 x 9,0 4,5 ● 0,16

passend für 15 Fingerfoodteller
oder 15 Schalen (83912 oder 83913)



Edelstahl Tablett
GN1/1
11119

stainless tray
GN1/1
11119

Melamin Tablett
GN1/1
83828

melamin tray
GN1/1
83828

designed by EsserDesign



Schale „ORGANIC“
bowl
cuenco
bol



	cm	↑ cm	ltr.	
84235 9	32,5 x 17	5,5	1	○
84236 6	50,0 x 26	6,5	3,5	○
84237 3	32,5 x 17	5,5	1	●
84238 0	50,0 x 26	6,5	3,5	●



84235



84238

designed by EsserDesign

**Schale „BIG WAVE“
bowl
cuenco
bol**



	▣ cm	↑ cm	ltr.
83587 0	33,0 x 24,0	8,5	1

**Schale
bowl
cuenco
bol**



0,45 und 0,80 Liter

	▣ cm	↑ cm	ltr.
84028 7	21,0 x 14,5	9	0,45
84029 4	26,5 x 16,5	12	0,80

**Besteck-Ablage
cutlery rest
reposa cuchara
pose-cuillère**



mit rutschfestem Boden
with non-slip bottom
con pies antideslizantes
pieds anti-dérapants

	▣ cm	↑ cm
83897 0	26 x 13	4,5



Tablett „GOURMET“
tray
bandeja
plateau



mit 3 Absätzen Ø 4 cm
with 3 holes Ø 4 cm
con 3 agujeros Ø 4 cm
avec 3 trous Ø 4 cm

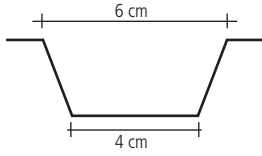

	cm	cm	cm
84017 1	30,5 x 9,5	2,5	



Schälchen „GOURMET“
bowl
cuenco
bol



	cm	cm	ml
84018 8	Ø 7	6	50



passend für Tablett
„Gourmet“
Nr. 84017

designed by **CULTURE FORM**

Serviertablett „KAFFEEHAUS“
tray
bandeja
tablette

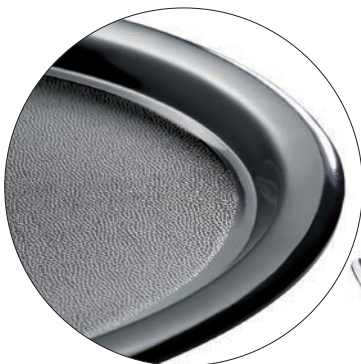

rutschfeste Oberfläche
non-slip surface
superficie anti-deslizante
surface anti-dérapante

	cm	cm	
84250 2	26,0 x 20,0	1,5	○
84252 6	28,5 x 21,5	1,5	○
84251 9	26,0 x 20,0	1,5	●
84253 3	28,5 x 21,5	1,5	●

84252



84251





Tortenplatte
cake tray
bandeja para tarta
plat à tarte



Rand fixiert die Haube, mit Antirutsch-Füßchen
 carved edge fixes the cover, non-slip feet
 ranura para fijar bien la campana, pies antideslizantes
 bord rainuré pour maintien ferme de la cloche, pieds anti-glisse

	□ cm	↑ cm	
00468 9	Ø 31	4	○
00469 6	Ø 31	4	●

Einzelteile / spare parts / piezas sueltas / pièces détachées



Frischhalte-Haube / cover / campana / cloche

06510 9	Ø 30	11,5	
06511 6	Ø 30	11,5	schwarzer Griff / black handle botón negro / bouton noir
06512 3	Ø 30	11,5	mit verchromtem Griff chrom plated handle botón cromado bouton chromé



Servierplatte
plate
bandeja para servir
plat de service



mit Antirutsch-Füßchen
 non-slip feet
 con pies antideslizantes
 avec pieds anti-dérapants

	□ cm	↑ cm	
83869 7	Ø 38	2,5	○

Einzelteile / spare parts / piezas sueltas / pièces détachées



Rolltop-Haube / rolltop cover / campana abatible / cloche basculante

18388 9	Ø 38	20	mit verchromtem Kugelgriff chrome plated handle pomo cromado bouton chromé
---------	------	----	---





Servier- und Tortenplatte „CASUAL“
 cake plate
 porta pateles
 présentoir à gâteaux



	cm	cm
83890 1	∅ 31	8
83891 8	∅ 31	16



Servier- und Tortenplatte „CASUAL“
 cake plate
 porta pateles
 présentoir à gâteaux



	cm	cm
83892 5	31 x 31	8
83893 2	31 x 31	16



83893

designed by **sieger design**



84046

Tablett „FRAMES“
 tray
 bandeja
 plat



	cm	cm	GN
84046 1	53,0 x 32,5	2	1/1
84047 8	32,5 x 26,5	2	1/2
84048 5	32,5 x 17,6	2	1/3

NEW

Eierbecher, 4er Set
egg holder, 4pcs. set
huevera, set de 4 unidades
coquetier, pack de 4



	□ cm	↑ cm	pcs.
83851 2	Ø 8	3	4

Eierbecher, 4er Set
egg holder, 4 pcs. set
huevera, set de 4 unidades
coquetier, pack de 4



	□ cm	↑ cm	pcs.
83848 2	Ø 8,5	2	4

Teller, rund „CASUAL“
plate, round
plato redondo
assiette ronde



	□ cm	↑ cm
83500 9	Ø 22,5	2,5
83514 6	Ø 26,5	2,5

Kaffeebecher „CASUAL“
coffee cup
taza de café
tasse à café



	□ cm	↑ cm	ltr.
83513 9	Ø 9,5	10	0,4

FRUITS designed by EsserDesign



83951



83952



83953



83954

Schale „FRUITS“ bowl cuenco saladier FRUITS

innen weiß
white inside
interior blanco
intérieur blanc



	☐ cm	↑ cm	ltr.	
83951 9	Ø 15	7,5	0,45	außen Erdbeer-Dekor outside strawberry decor exterior motivo de fresa extérieur motif fraise
83952 6	Ø 15	7,5	0,45	außen Orangen-Dekor outside orange decor exterior motivo de naranja extérieur motif orange
83953 3	Ø 15	7,5	0,45	außen Zitronen-Dekor outside lemon decor exterior motivo de limón extérieur motif citron
83954 0	Ø 15	7,5	0,45	außen Kiwi-Dekor outside kiwi decor exterior motivo de kiwi extérieur motif kiwi



3,3 ltr.
83968
ohne Dekor



3,3 ltr.
83969
ohne Dekor

Schale „FRUITS“ bowl cuenco saladier FRUITS

innen weiß
white inside
interior blanco
intérieur blanc



	☐ cm	↑ cm	ltr.	
83968 7	Ø 28	14	3,3	außen rot / outside red exterior rojo / extérieur rouge uni
83969 4	Ø 28	14	3,3	außen grün / outside green exterior verde / extérieur vert uni

FINGERFOOD LÖFFEL

PARTY SPOON / CUCHARA PARTY / CUILÈRE PARTY



NEW



Löffel „HALFTONE“
spoon
cuchara
cuillère



	□ cm	↑ cm	●	
84158 1	Ø 5,5	7	●	white / black



84128

Fingerfood Löffel „BOAT“
party spoon
cuchara party
cuillère party



	□ cm	↑ cm	●	
84128 4	14,5 x 4,5	4,5	●	white / black
84140 6	14,5 x 4,5	4,5	○	white
84141 3	14,5 x 4,5	4,5	●	black
84142 0	14,5 x 4,5	4,5	●	lemon-green
84143 7	14,5 x 4,5	4,5	●	mint





Fingerfood-Löffel „HONG KONG“
party spoon
cuchara party
cuillère party



	☐ cm	↑ cm	
83486 6	13 x 4,5	4,5	○
83487 3	13 x 4,5	4,5	●
83424 8	13 x 4,5	4,5	●
83426 2	13 x 4,5	4,5	●

designed by EsserDesign



Fingerfood-Löffel „MING HING“
party spoon
cuchara party
cuillère party



	☐ cm	↑ cm	
83842 0	11 x 4,5	4	○
83843 7	11 x 4,5	4	●

designed by EsserDesign



Fingerfood-Löffel „YING YANG“
party spoon
cuchara party
cuillère party



	☐ cm	↑ cm	
83844 4	10 x 4,5	1,5	○
83845 1	10 x 4,5	1,5	●

designed by **formel²³**
PRODUKTDESIGN



Fingerfood-Löffel „LEAF“
party spoon
cuchara party
cuillère Party



	☐ cm	↑ cm	
83887 1	10 x 4,5	1,5	○
83888 8	10 x 4,5	1,5	●
83889 5	10 x 4,5	1,5	●



Fingerfood-Löffel „FISH“
party spoon
cuchara party
cuillère party



	☐ cm	↑ cm	
83850 5	10,5 x 4,5	2,5	

NEW

HOT PRICE

Dressinglöffel
dressing spoon
cuchara de aliño
cuillère à sauce



	cm	→ cm	
88636 0	Ø 6	34	○
88609 4	Ø 6	34	●



Dressingtopf „CASUAL“
dressing pot
salsera alta
saucière



	cm	↑ cm	litr.	
83867 3	Ø 12	21,5	1	○
83868 0	Ø 12	21,5	1	●



Salat-Löffel
salad spoon
cuchara
cuillère



	cm	↑ cm
84036 2	24 x 7	4



Salat-Löffel
salad spoon
cuchara
cuillère



	cm	↑ cm
84035 5	24 x 7	4,5

**HOT
PRICE**



Feinkostlöffel, 6er Set
delicatessen spoon, 6 pcs. set
juego de 6 cucharas gourmet
jeu de 6 cuillères gourmet

SAN
KUNSTSTOFF



	cm	→ cm	pcs.	
88626 1	∅ 6	23	6	<input type="radio"/> transparent

**HOT
PRICE**



Feinkostlöffel, 6er Set
delicatessen spoon, 6 pcs. set
juego de 6 cucharas gourmet
jeu de 6 cuillères gourmet

SAN
KUNSTSTOFF



	cm	→ cm	pcs.	
88627 8	∅ 6	23	6	<input type="radio"/>

**HOT
PRICE**



Feinkostlöffel, 6er Set
delicatessen spoon, 6 pcs. set
juego de 6 cucharas gourmet
jeu de 6 cuillères gourmet

SAN
KUNSTSTOFF



	cm	→ cm	pcs.	
88628 5	∅ 6	23	6	<input checked="" type="radio"/>

**HOT
PRICE**



Feinkost- / Olivenlöffel, 6er Set
delicatessen / oliven spoon, 6 pcs. set
juego de 6 cucharas para olivas
jeu de 6 cuillères à olives

SAN
KUNSTSTOFF



geloct
perforated
perforadas
perforées

	cm	→ cm	pcs.	
88598 1	6 x 9	27	6	<input checked="" type="radio"/>

designed by **CULTURE FORM**



84020



84021



Servierlöffel „PROFI“
serving-spoon
cuchara
cuillère



	cm	→ cm	
84020 1	7 x 6,5	26,5	○
84021 8	7 x 6,5	26,5	●



rutschsicher /
slip-proof



gerade
Portionierkante /
easy cutting



einfach abstreifen /
simply wipe off



Tiefe Ecken? - Kein Problem!
Deep corners? No problem!



10 Schilderhalter „FLEX CLIP“
10 sign holders
pack de 10 clips
pack de 10 porte-étiquettes



Durch die bewegliche Verbindung der Klemme und Schilderhalterung ein extrem flexibler Cliphalter!

multi angle ticket clip
 inclinable con pinza
 inclinable avec pince
 → cm

71472	4	9,5	○ elfenbein
71473	1	12,5	○ elfenbein
71474	8	9,5	●
71475	5	12,5	●

Zubehör / spare parts / recambios / pièces de rechange

passende Schilder, 10er Set / fitting signs, 10 pcs. set
 set de 10 cartelitos / set de 10 étiquettes

	cm	pcs.
11879	9 7,7 x 5,2	10
12879	8 5,0 x 3,0	10



10 Beschriftungsclips, inkl. 10 Schilder
10 sign holders, with 10 signs
10 soportes + 10 cartelitos
10 supports + 10 étiquettes



	cm	pcs.	
71482	3 6 x 2,7	10	○
71483	0 6 x 2,7	10	●

Einzelteile / spare parts / piezas sueltas / pièces détachées

passende Schilder, 10er Set / fitting signs, 10 pcs. set
 set de 10 cartelitos / set de 10 étiquettes

11879	9 7,7 x 5,2	10
-------	-------------	----



Schilderhalter „FLEXIBEL“
sign holder
soporte para cartelito
support pour menu de table



biegsamer Draht mit zwei Klemmen, extrem flexibel, die Klemmen lassen sich weit öffnen
 bedable metal coil adds visual interest, two metal clip open
 metal cromado flexible, 2 pinzas con gran apertura
 métal chromé, flexible, 2 pinces à grande ouverture

	→ cm	
71470	0 12	ohne Schilder / without signs sin cartelitos / sans étiquette
71471	7 23	ohne Schilder / without signs sin cartelitos / sans étiquette
71480	9 12	inkl. 10 Schilder 11879 / incl. 10 signs 11879 con 10 cartelitos 11879 / avec 10 étiquettes 11879
71481	6 23	inkl. 10 Schilder 11879 / incl. 10 signs 11879 con 10 cartelitos 11879 / avec 10 étiquettes 11879

BUFFET-LEITER „GN“ NEW



„LITTLE GN“



Buffet-Leiter „LITTLE GN 1/3“
buffet ladder
dispensador en escalera
présentoir buffet en escalier



4-teilig: 1 Leiter-Gestell, 3 GN 1/3 Rahmen
 4 pcs.: 1 ladder, 3 single rings GN 1/3
 4 pz: 1 soporte escalera, 3 aros sencillos GN 1/3
 4 pc: 1 support escalier, 3 cercles simples GN 1/3

	cm	cm	matches
11526 2	31,5 x 32	48	baskets/pans GN 1/3



Buffet-Leiter „LITTLE GN 1/2“
buffet ladder
dispensador en escalera
présentoir buffet en escalier



4-teilig: 1 Leiter-Gestell, 3 GN 1/2 Rahmen
 4 pcs.: 1 ladder, 3 single rings GN 1/2
 4 pz: 1 soporte escalera, 3 aros sencillos GN 1/2
 4 pc: 1 support escalier, 3 cercles simples GN 1/2

	cm	cm	matches
11527 9	31,5 x 41,5	48	baskets/pans GN 1/2

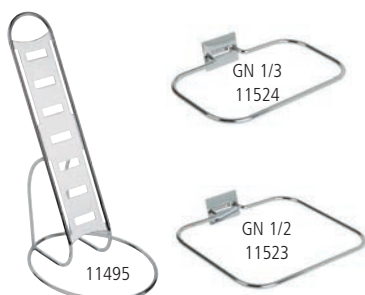

Einzelteile / spare parts / piezas sueltas / pièces détachées

Leiter-Gestell / frame / estructura en escalera / support en escalier	11495 1
Einzelring GN 1/3 / single ring GN 1/3 / aro sencillo GN 1/3 / cercle simple GN 1/3	11524 8
Einzelring GN 1/2 / single ring GN 1/2 / aro sencillo GN 1/2 / cercle simple GN 1/2	11523 1



„BIG GN“



Set
11528

Buffet-Leiter „BIG GN 1/2“ buffet ladder dispensador en escalera présentoir buffet en escalier



- 5-teilig: 1 Leiter-Gestell, 4 GN 1/2 Rahmen
 5 pcs.: 1 ladder, 4 single rings GN 1/2
 5 pz: 1 soporte escalera, 4 aros sencillos GN 1/2
 5 pc: 1 support escalier, 4 cercles simples GN 1/2

	☐ cm	↑ cm	matches
11528 6	31,5 x 56	66	baskets/pans GN 1/2

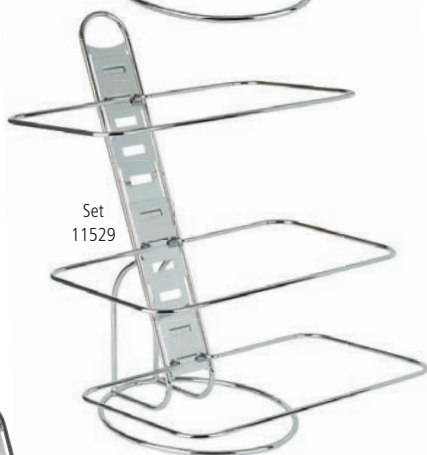

Set
11529

Buffet-Leiter „BIG GN 1/1“ buffet ladder dispensador en escalera présentoir buffet en escalier



- 4-teilig: 1 Leiter-Gestell, 3 GN 1/1 Rahmen
 4 pcs.: 1 ladder, 3 single rings GN 1/1
 4 pz: 1 soporte escalera, 3 aros sencillos GN 1/1
 4 pc: 1 support escalier, 3 cercles simples GN 1/1

	☐ cm	↑ cm	matches
11529 3	52 x 59	66	baskets/pans GN 1/1



11595



Einzelteile / spare parts / piezas sueltas / pièces détachées

Leiter-Gestell / frame / estructura en escalera / support en escalier

11595 8

Einzelring GN 1/2 / single ring GN 1/2 / aro sencillo GN 1/2 / cercle simple GN 1/2

11523 1

Einzelring GN 1/1 / single ring GN 1/1 / aro sencillo GN 1/1 / cercle simple GN 1/1

11522 4

BUFFET-STÄNDER KING designed by CULTURE FORM



Buffet-Ständer „KING“ buffet stand soporte para bufet présentoir buffet



kein Verrutschen, Arme und Boden sind mit Antirutschflächen ausgestattet, schwere standsichere Qualität, Fuß dient als Löffelablage

the arms and base are equipped with non-slip surfaces, stable quality, base serves as spoon holder

anti-deslizante: revestimiento antideslizante en las puntas de los brazos y en la base. Estable y alta calidad. la base sirve como reposacuchara

anti-glisse - : revêtement anti-dérapant sur les extrémités des 3 pieds et sur la base. Robuste, stable et bonne qualité. La base sert de support pour les couverts



	□ cm	↑ cm
03622 2	Ø 15	14
03623 9	Ø 15	21



BUFFET-STÄNDER designed by CULTURE FORM



Buffet-Ständer „STAR“
buffet stand
soporte para buffet
présentoire buffet



Metall, mit schwarzer Antirutschgummierung
 metal, with black anti-slide coating
 acero cromado, con recubrimiento negro antideslizante
 metal avec revêtement plastique noir anti-glisse

	↑ cm
33260 7	8
33261 4	12
33262 1	18



- DE** Wir behalten uns das Recht vor, die angegebenen Spezifikationen jederzeit zu ändern. Irrtum, Druckfehler und technische Änderungen vorbehalten. Artikelbeschreibungen sowie Abbildungen und Fotodarstellungen sind ohne Gewähr. Alle Angebote ohne Dekoration.
© COPYRIGHT - Die Vervielfältigung dieses Kataloges - auch wenn partial - muß ausschließlich von der Assheuer + Pott GmbH & Co. KG genehmigt werden.
- GB** We reserve the right to alter at any time the specifications stated without notice. Errors, printing error and technical changes reserved. Item discription as well as images and illustrations are without guaranty. All offers are without decoration.
© COPYRIGHT - This catalogue may not be reproduced in whole or in part unless specific prior written authorization of Assheuer + Pott GmbH & Co. KG.
- ES** Las medidas indicadas son a titolu informativo y pueden variar sin algun previo aviso. Sin perjuicio de errores de imprenta o impresión o cambios técnicos. La descripción de los artículos, sus imágenes e ilustraciones no están sujetas a garantía. Los artículos se ofrecen sin decoración.
© COPYRIGHT - Todas reproducciones, aunque parciales, de este catálogo tienen que ser autorizadas por escrito de Assheuer + Pott GmbH & Co. KG.
- PT** Reservamo-nos o direito de alterar a qualquer momento as especificações publicadas sem qualquer aviso prévio. Erros, erros de impressão e alterações técnicas reservados. Descrição dos artigos, bem como imagens e ilustrações são sem garantia, todas as ofertas não incluem a decoração.
© COPYRIGHT - Este catálogo não poderá ser reproduzido em parte ou na totalidade, sem autorização prévia por escrito da Assheuer + Pott GmbH & Co. KG.
- FR** Nous nous réservons le droit de modifier à tout moment les spécifications techniques.
© COPYRIGHT - Toute reproduction partielle de ce catalogue est interdite sauf expréssautorisation de Assheuer + Pott GmbH & Co. KG.



Assheuer + Pott GmbH & Co. KG
Talweg 11, 59846 Sundern, Germany

Telefon +49 (0) 29 33/97 35-0
Telefax +49 (0) 29 33/97 35-35 (Zentrale)
Telefax +49 (0) 29 33/97 35-34 (Export)
www.aps-germany.de
info@aps-germany.de

